

Tailors: Accelerating Sparse Tensor Algebra by Overbooking Buffer Capacity

Zi Yu (Fisher) Xue¹, Yannan Nellie Wu¹, Joel S. Emer^{1,2}, Vivienne Sze¹

¹MIT ²NVIDIA

<http://emze.csail.mit.edu/tailors>

Many applications use highly sparse tensors

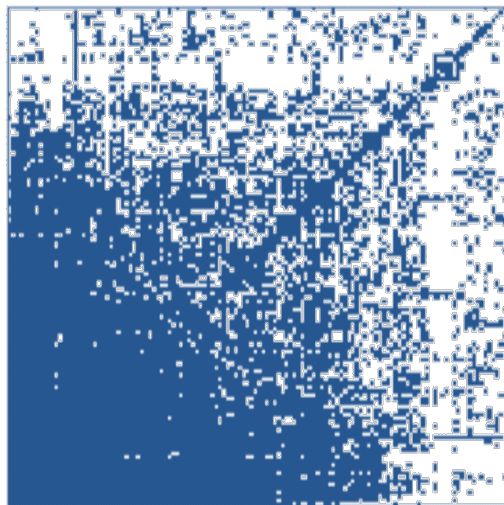
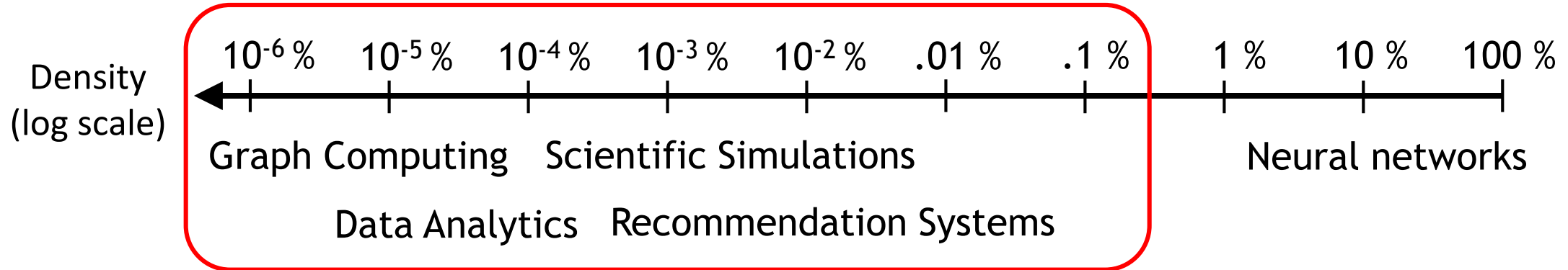

367K nonzeros

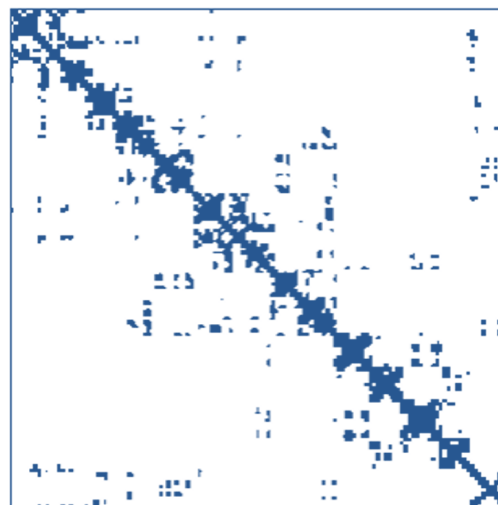

4.34M nonzeros



3.20M nonzeros

Zero Values

Nonzero Values

Tiling reduces loads of nonstationary tiles

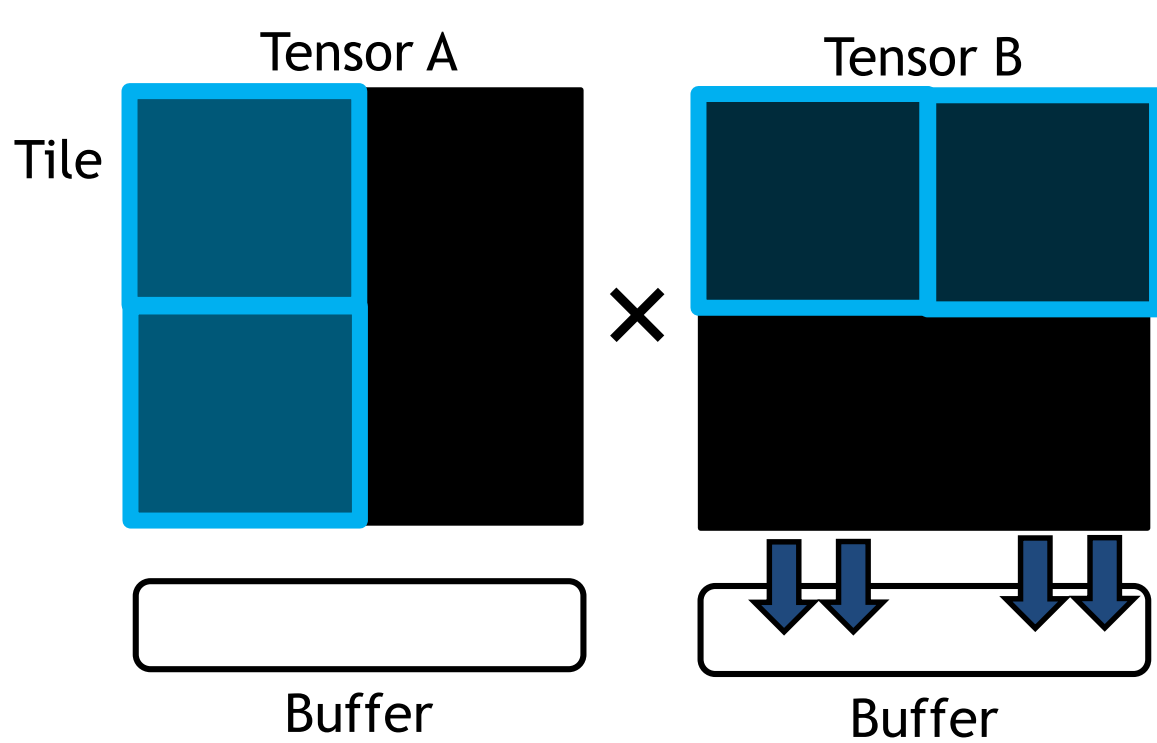

Tiling reduces loads of nonstationary tiles

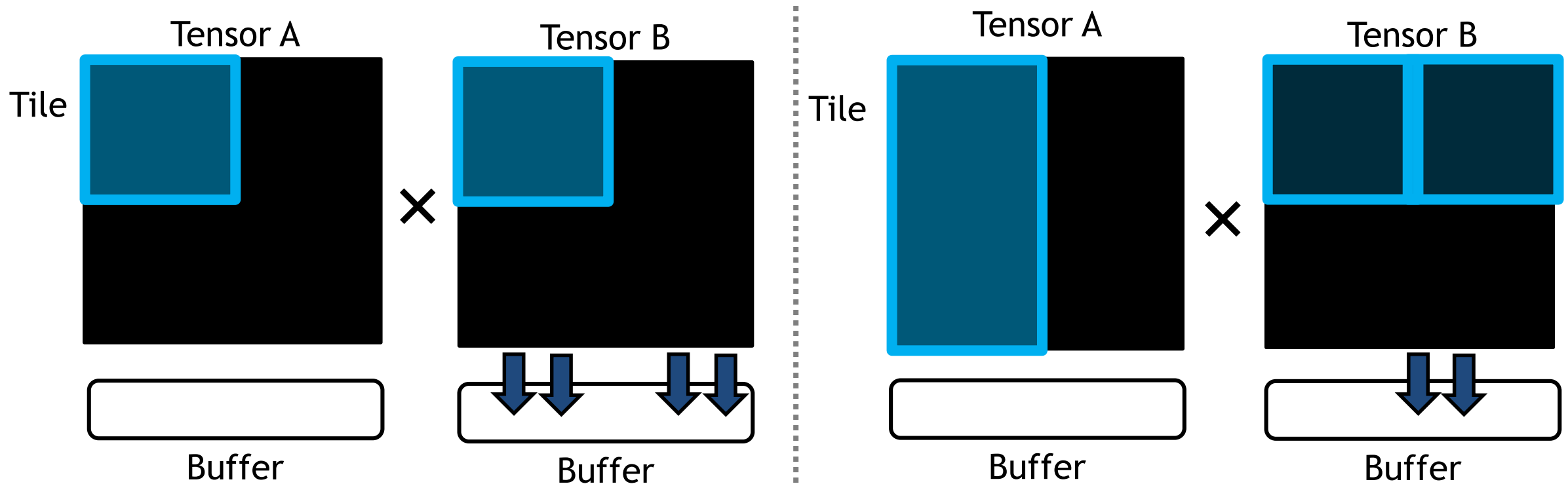

Larger tile sizes → greater data reuse → less DRAM traffic

Tiling sparse tensors is challenging

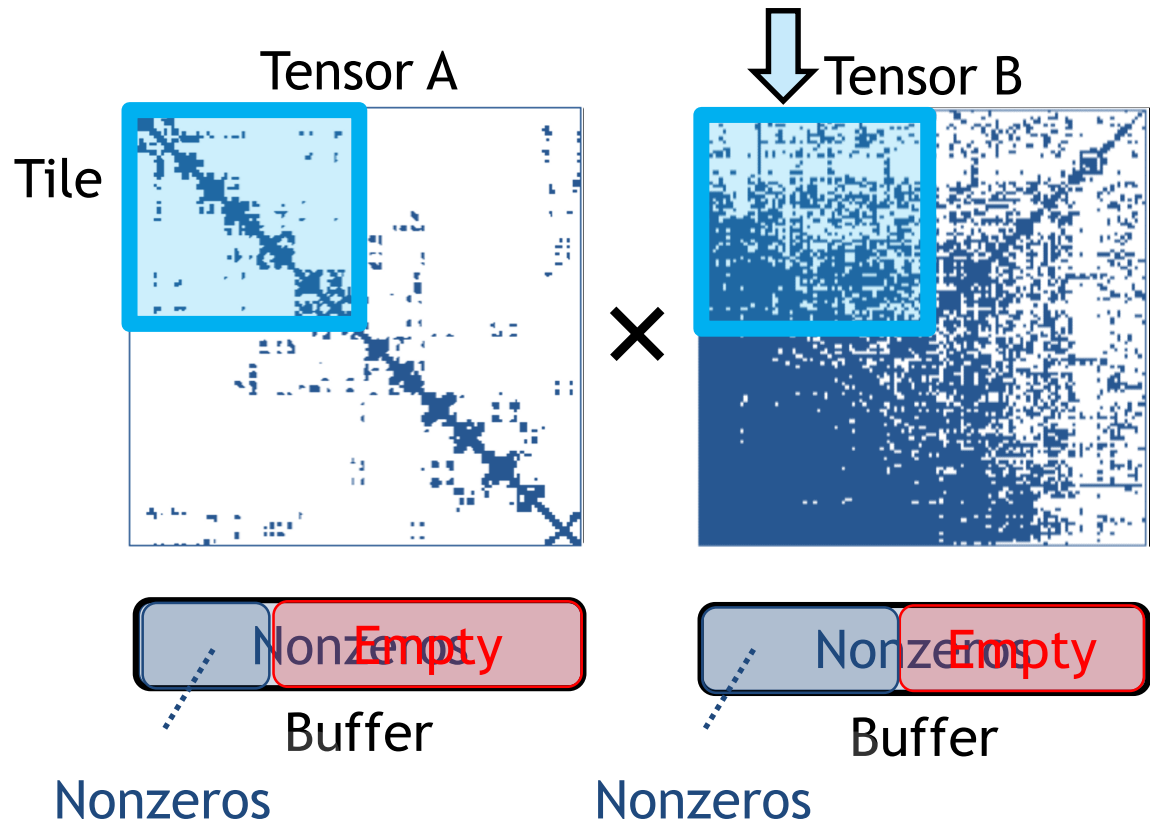

Tensors vary in the *distribution* of sparsity

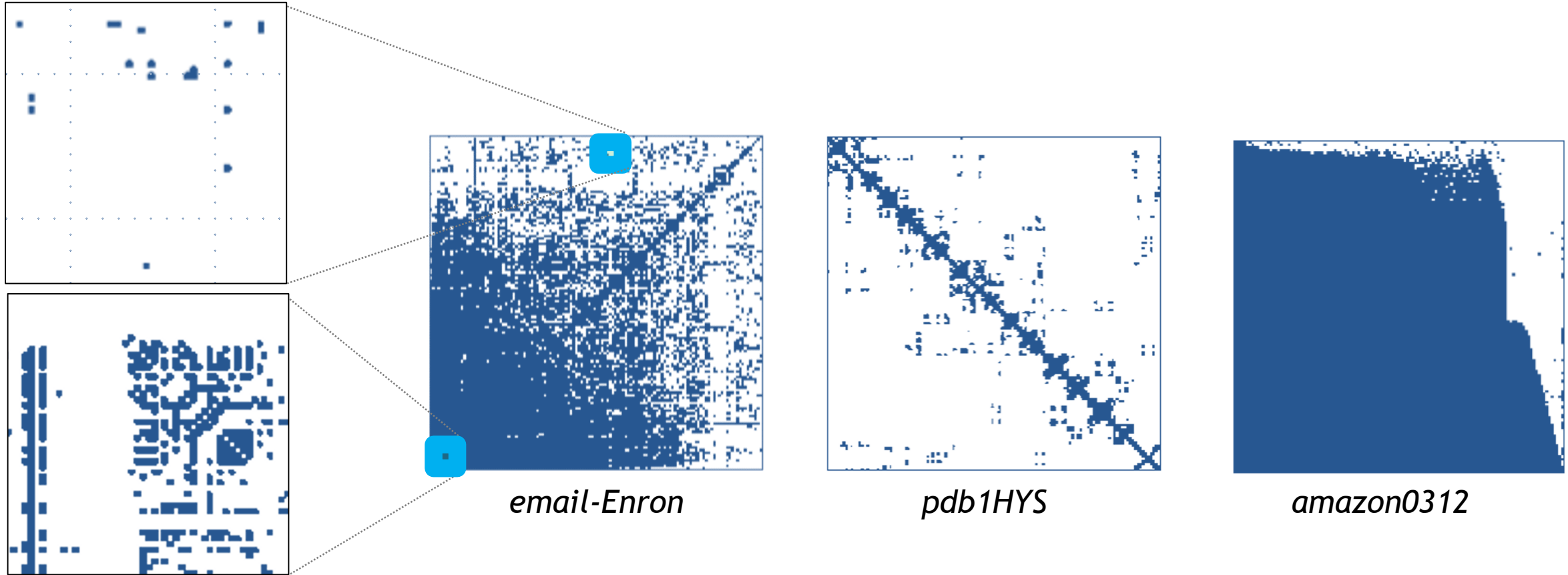

Tiling with *uniform occupancy*

- Always fetch enough nonzeros to fill the buffer (**ideal buffer utilization**)
- Leads to non-uniform tile shapes (**hard to tile other operand**)

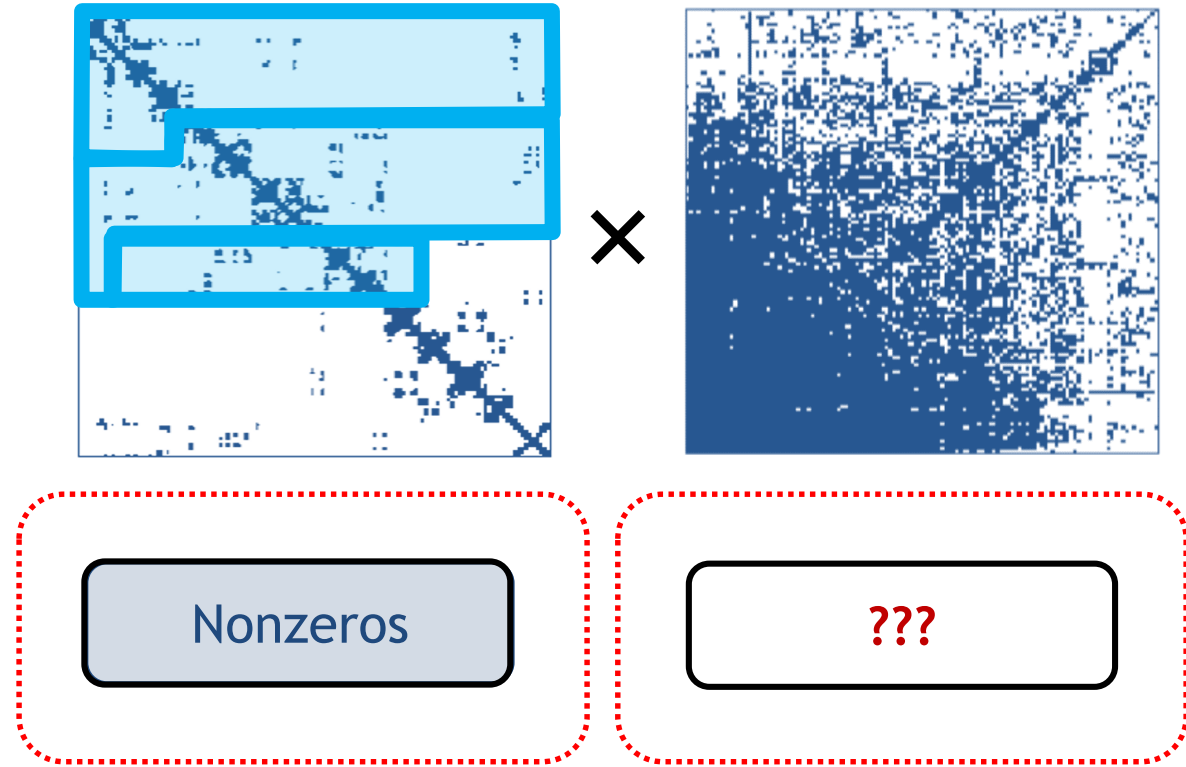

Tiling with *uniform occupancy*

- + ideal buffer utilization
- hard to tile other operand

Tiling with *uniform shape*

- + Always construct tiles with the same shape (easy to tile both operands)
- All tiles must fit within the buffer (low buffer utilization)

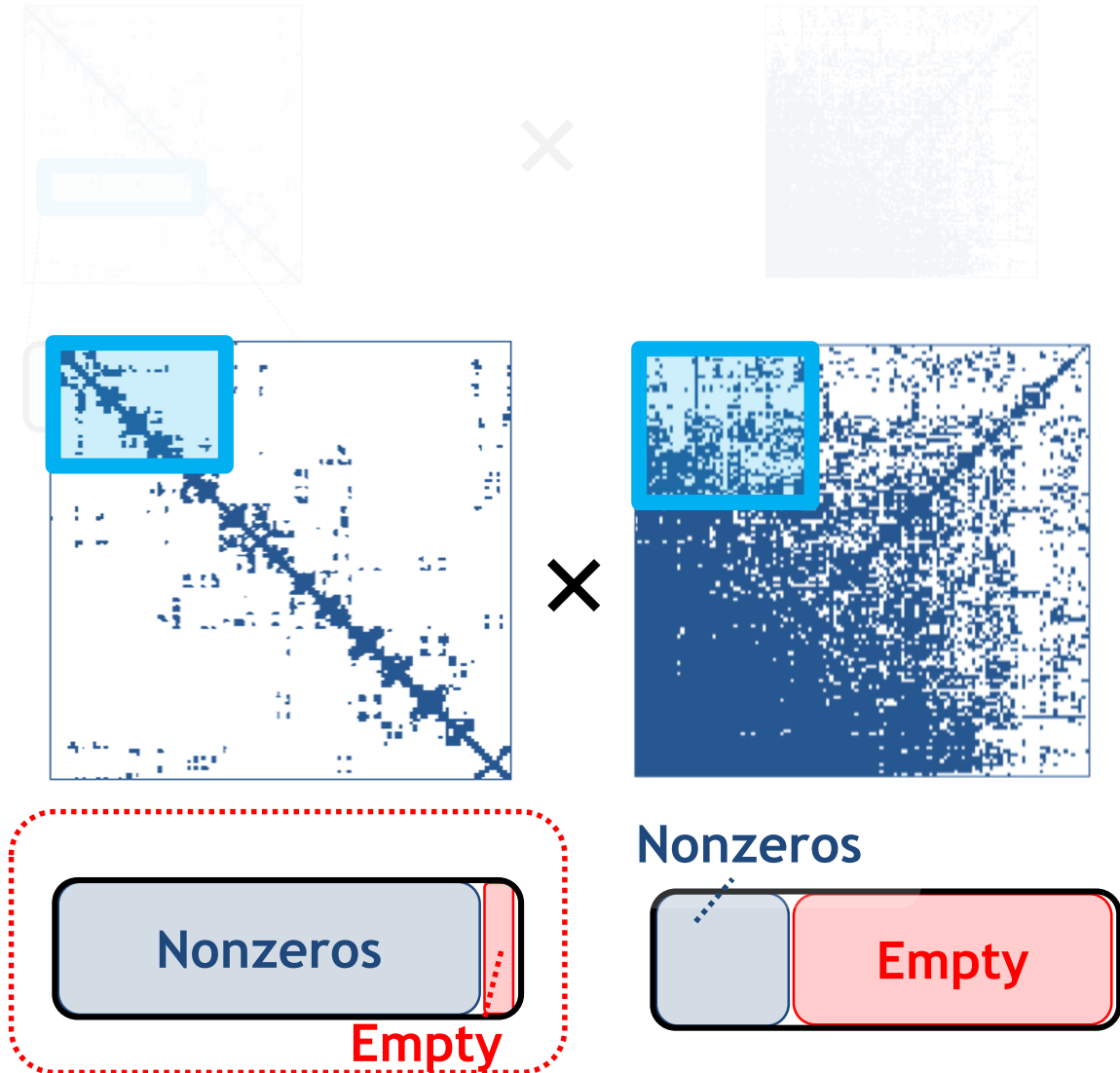

Tiling with *uniform occupancy*

- + ideal buffer utilization
- hard to tile other operand

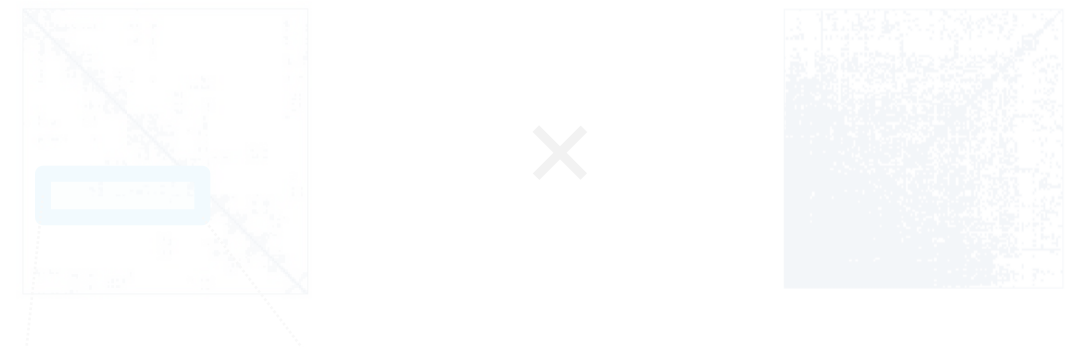

Tiling with *uniform shape*

- + Always construct tiles with the same shape (easy to tile both operands)
- All tiles must fit within the buffer (low buffer utilization)

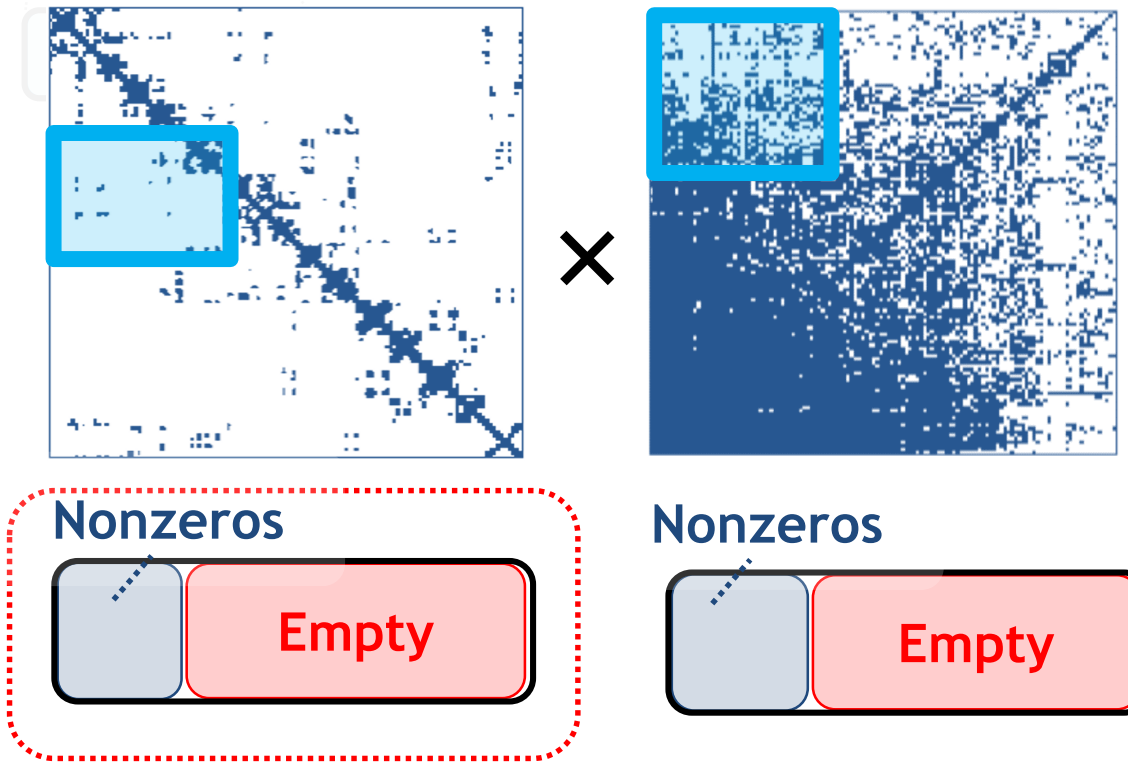

Tiling with *uniform occupancy*

- + ideal buffer utilization
- hard to tile other operand

Tiling with *uniform shape*

- + Always construct tiles with the same shape (easy to tile both operands)
- All tiles must fit within the buffer (low buffer utilization)

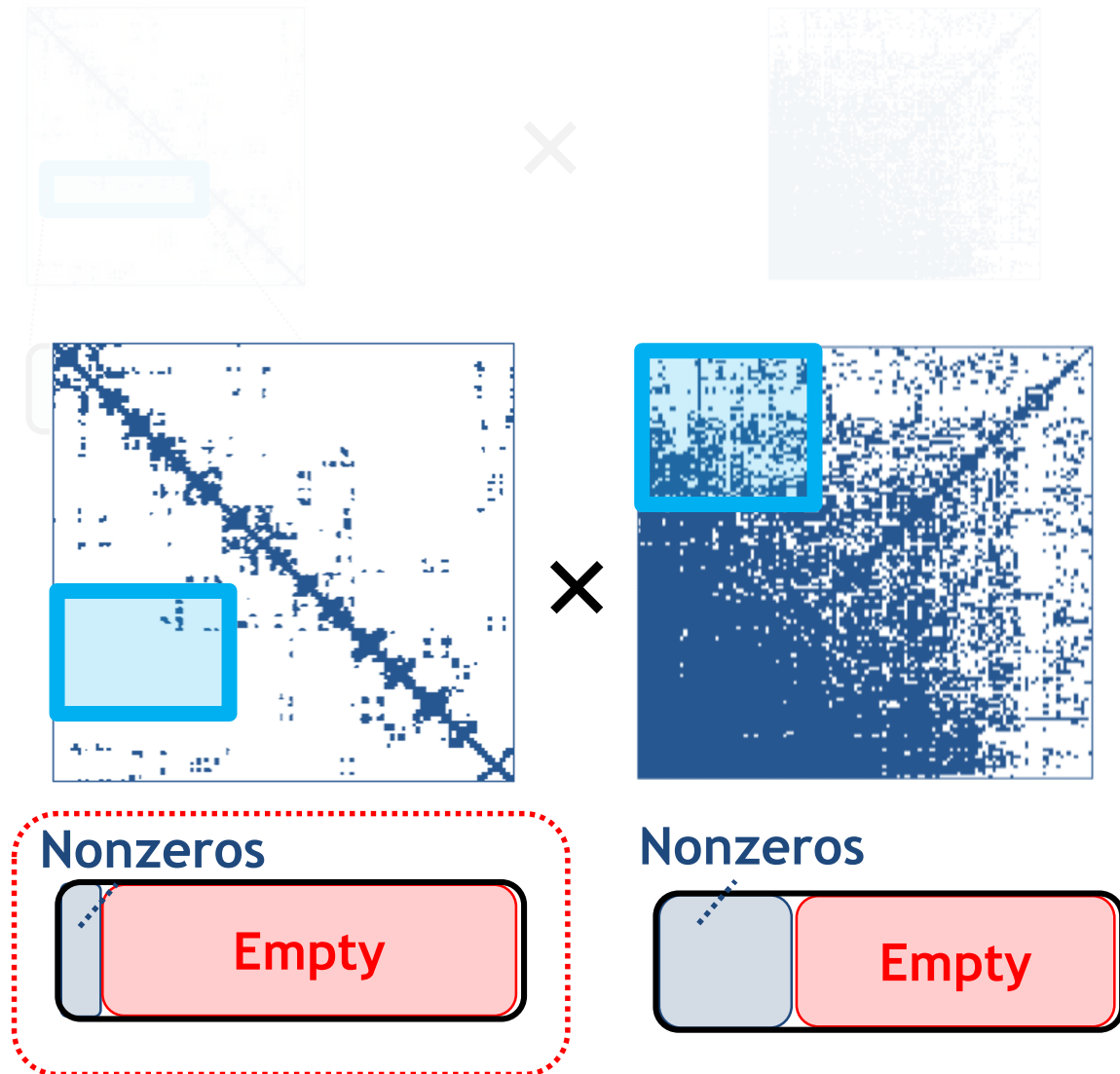

Uniform shape tiling has poor buffer utilization

- Constructing tiles based on the maximum tile occupancy may overprovision buffer space
- Most tiles do not fully occupy the buffer

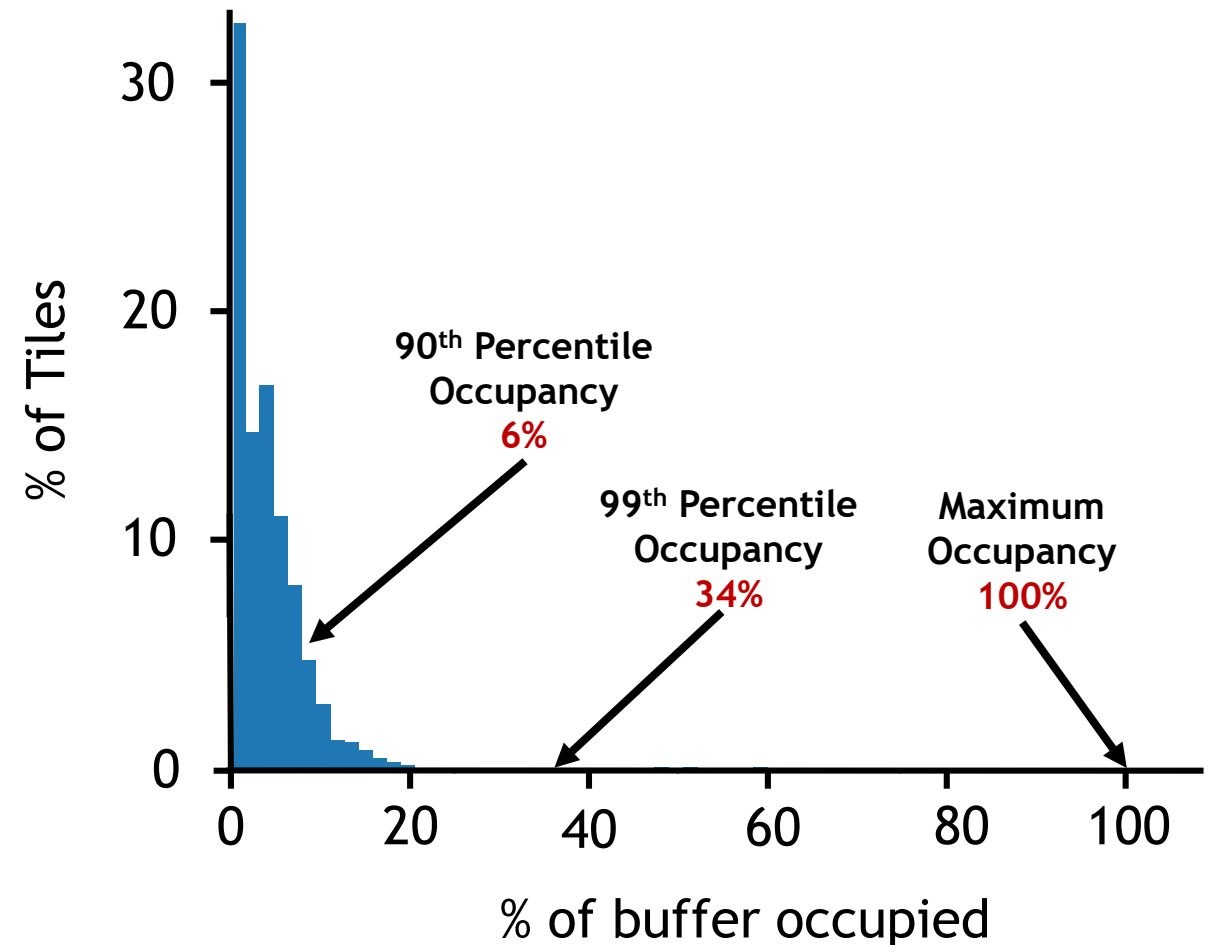



What if we could overbook buffer capacity?

Sparsity leads to poor utilization

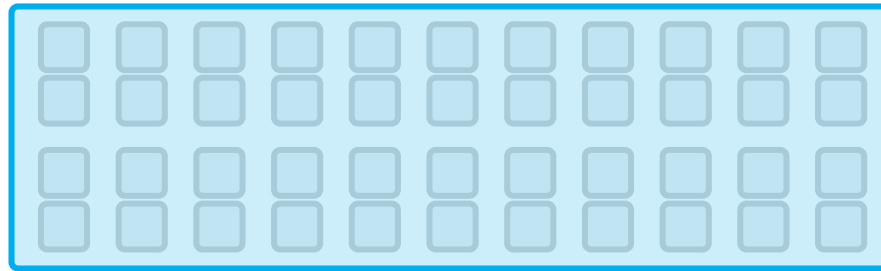

Tickets Sold

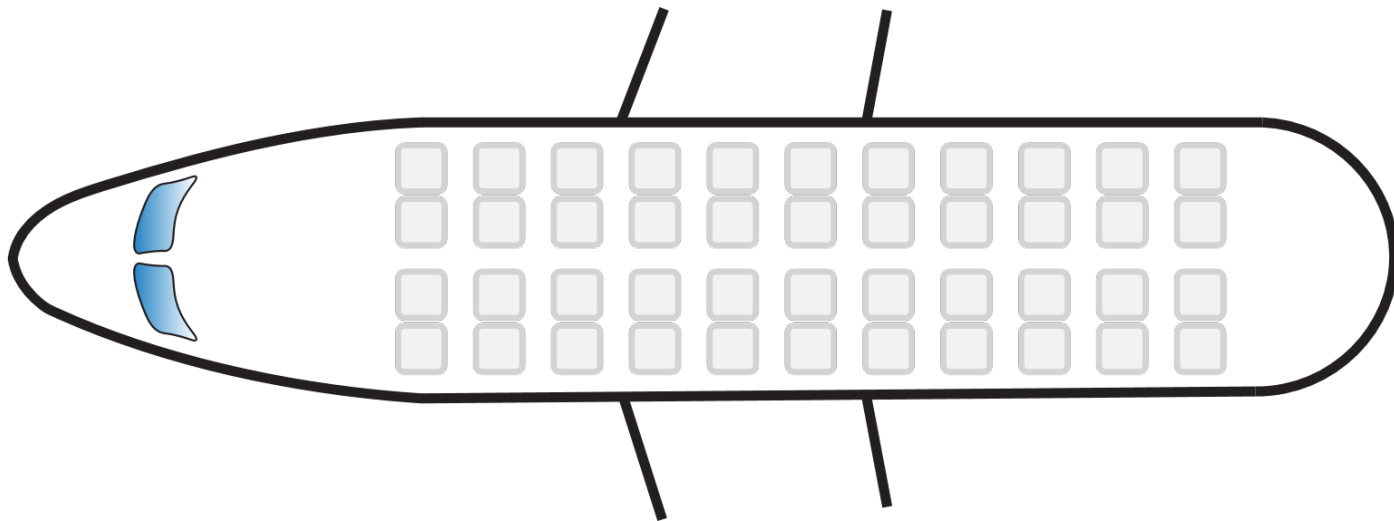

Sparsity leads to poor utilization

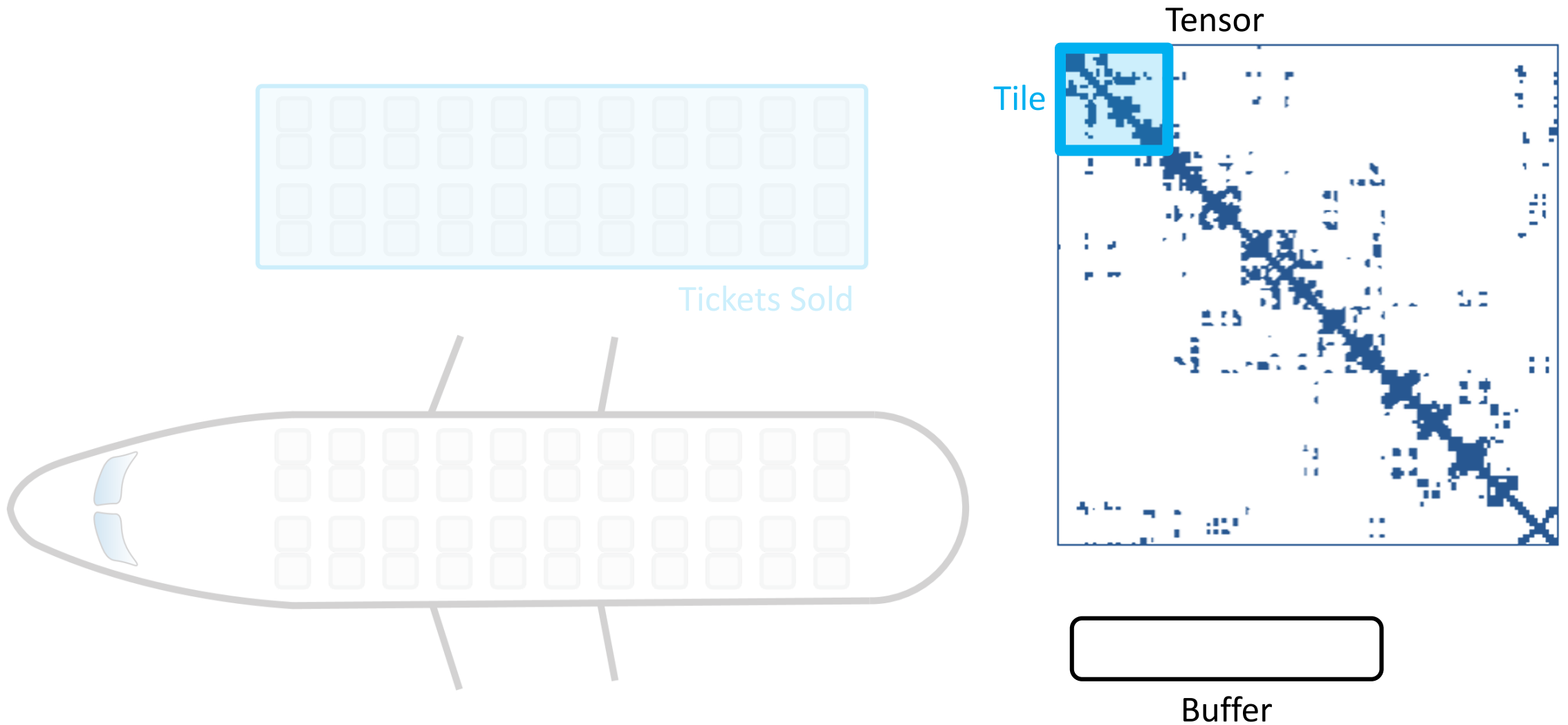

Sparsity leads to poor utilization

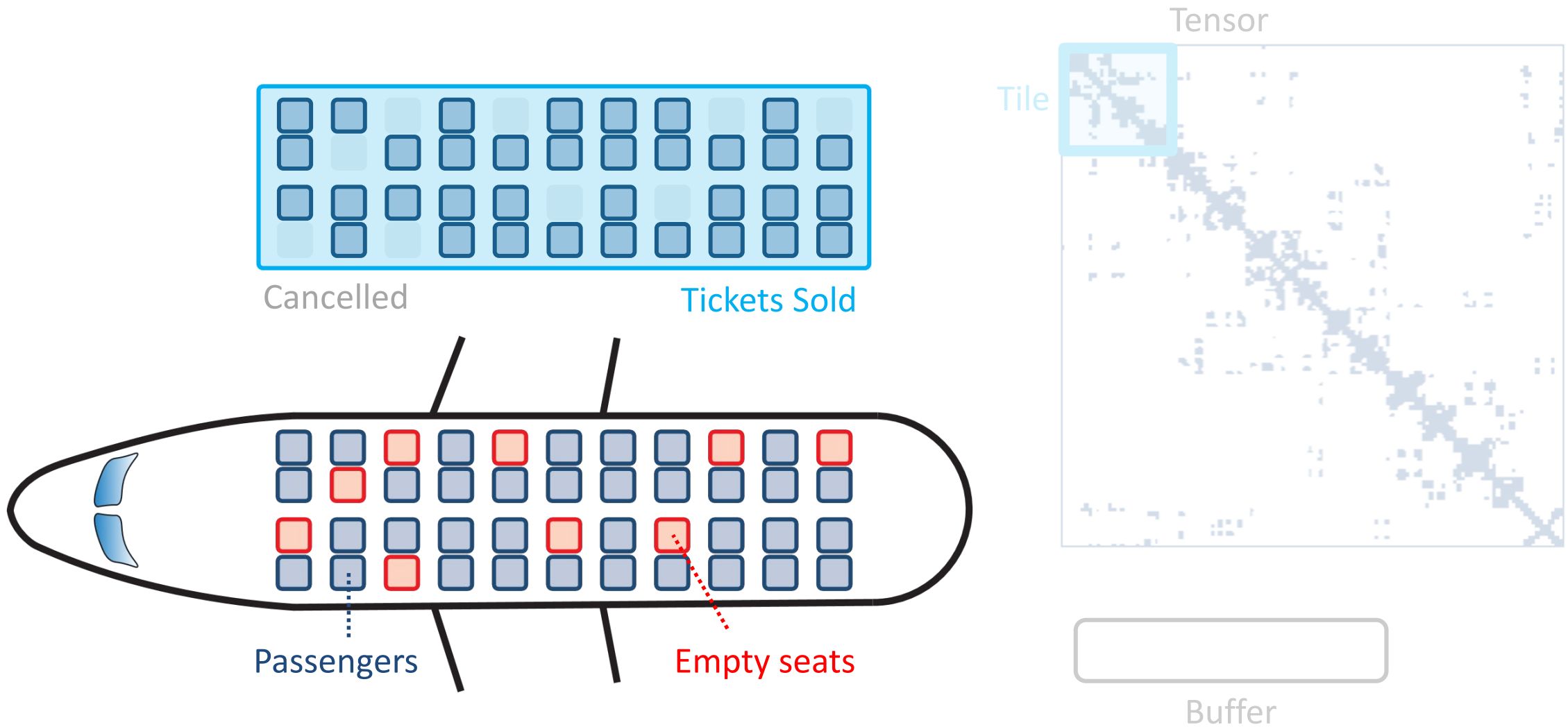

Sparsity leads to poor utilization

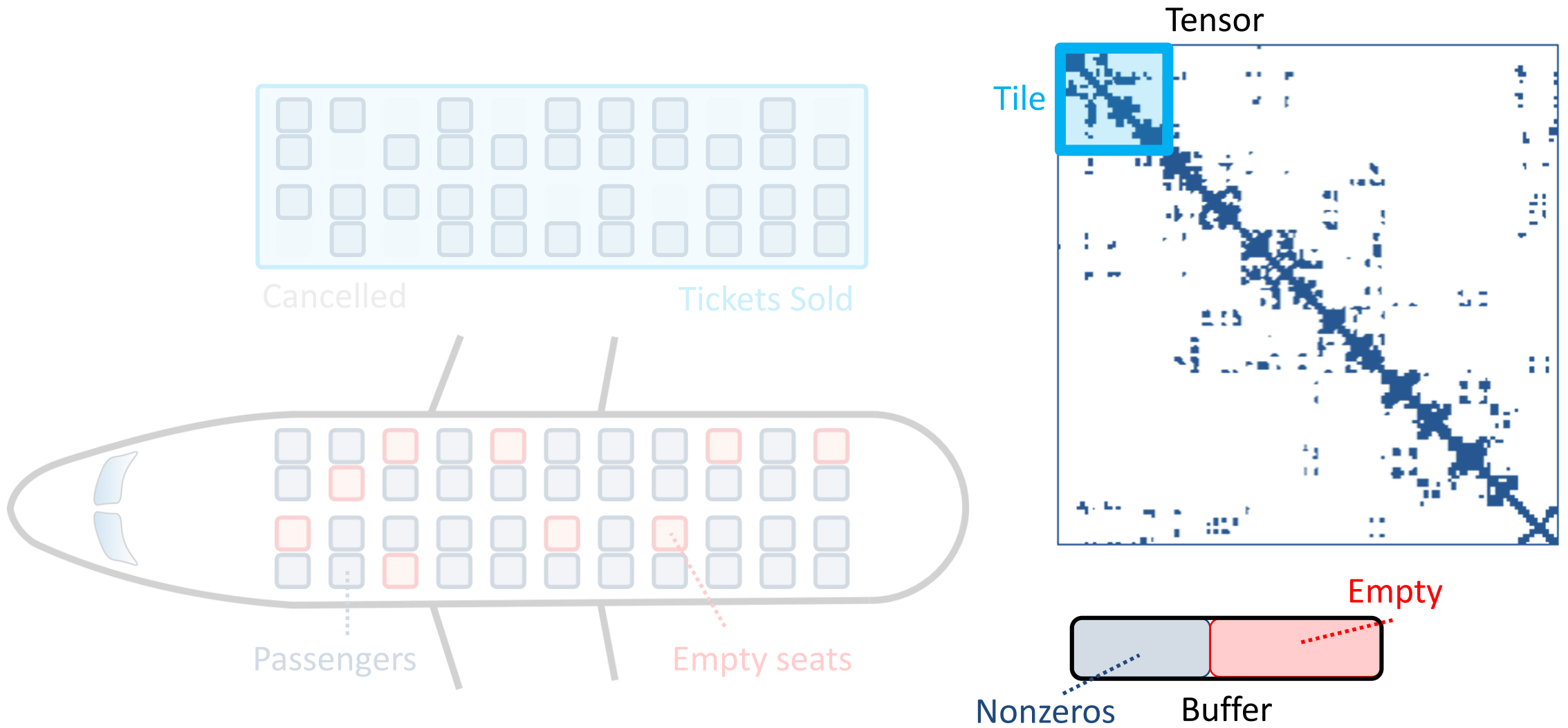

Overbooking improves utilization

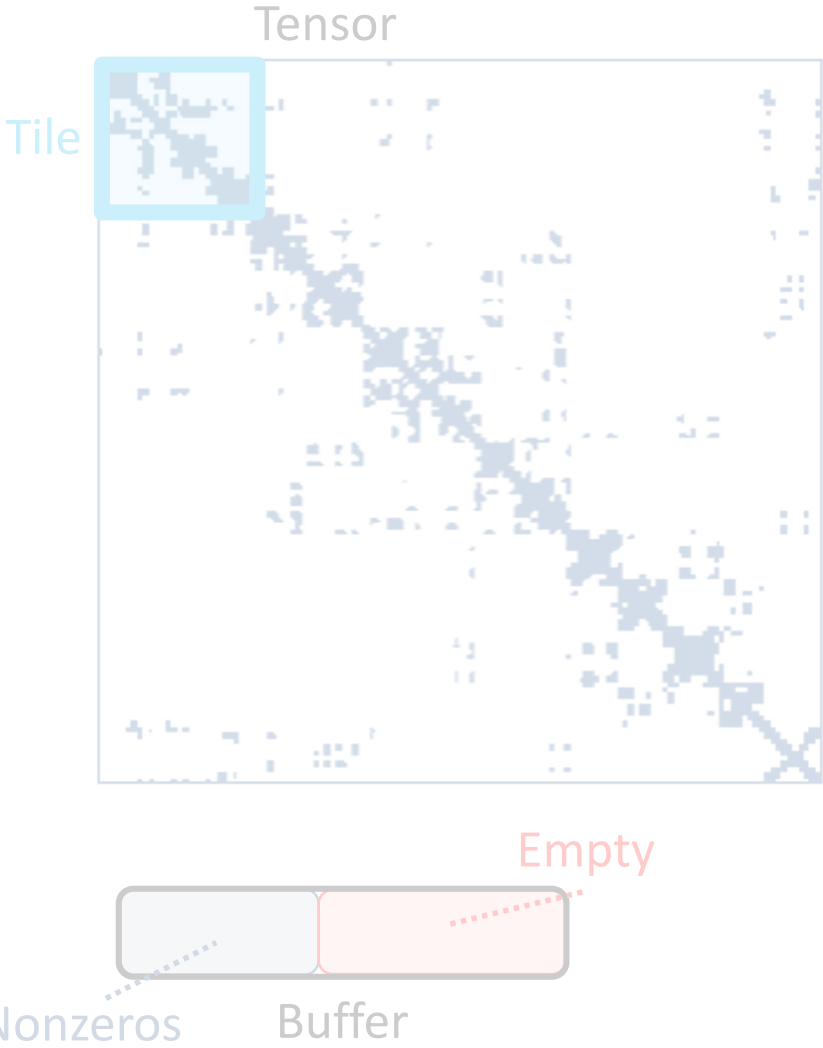
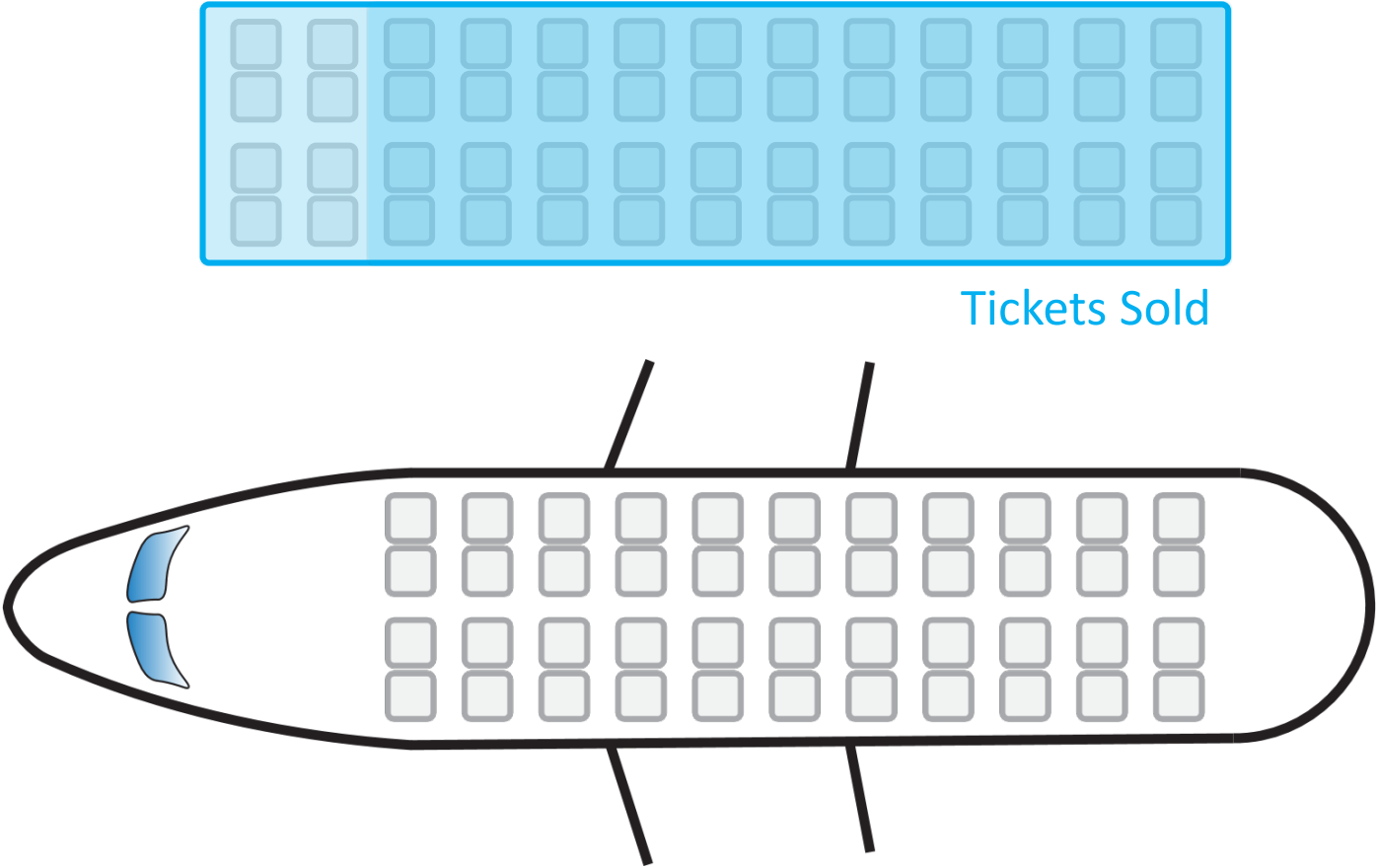

Overbooking improves utilization

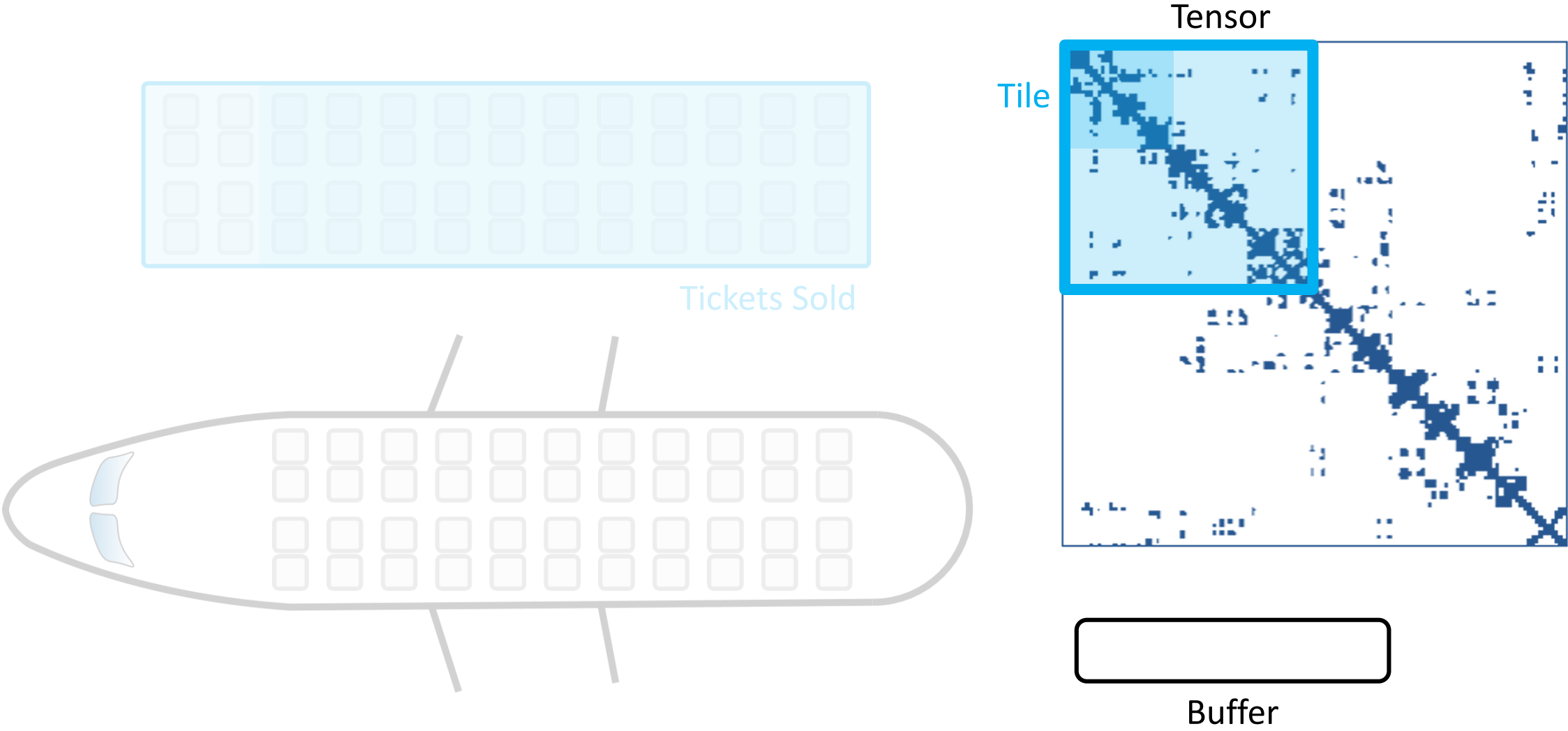

Overbooking improves utilization

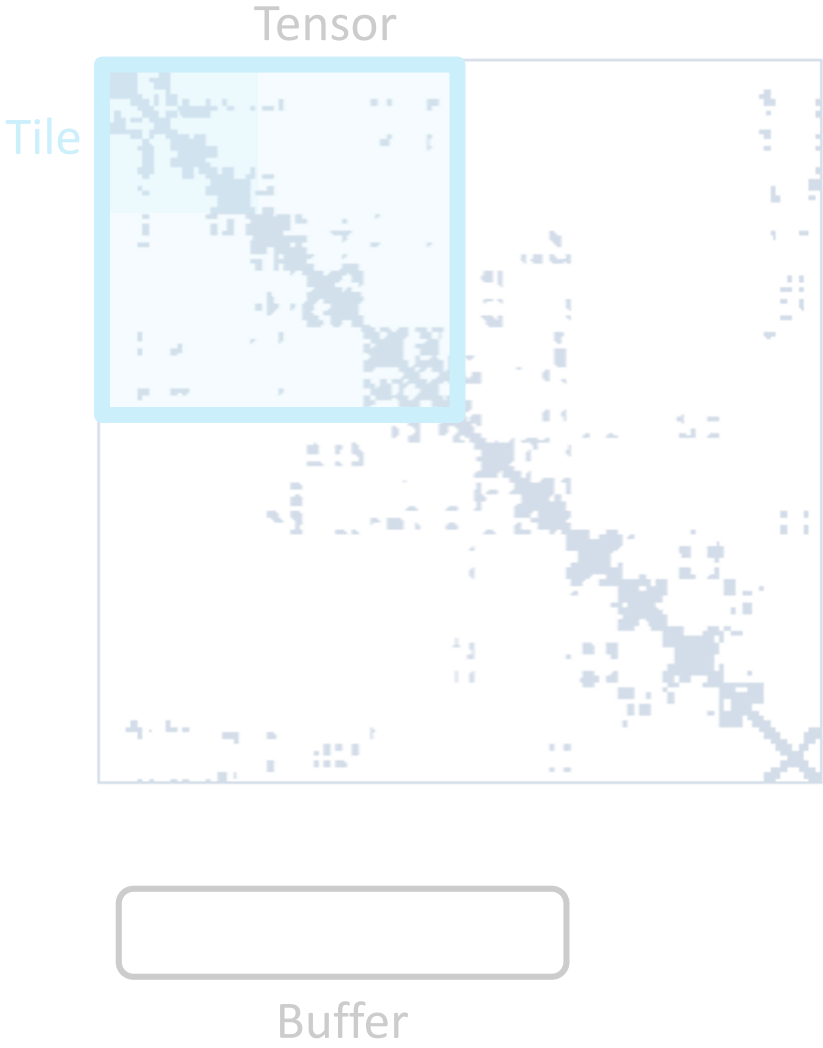
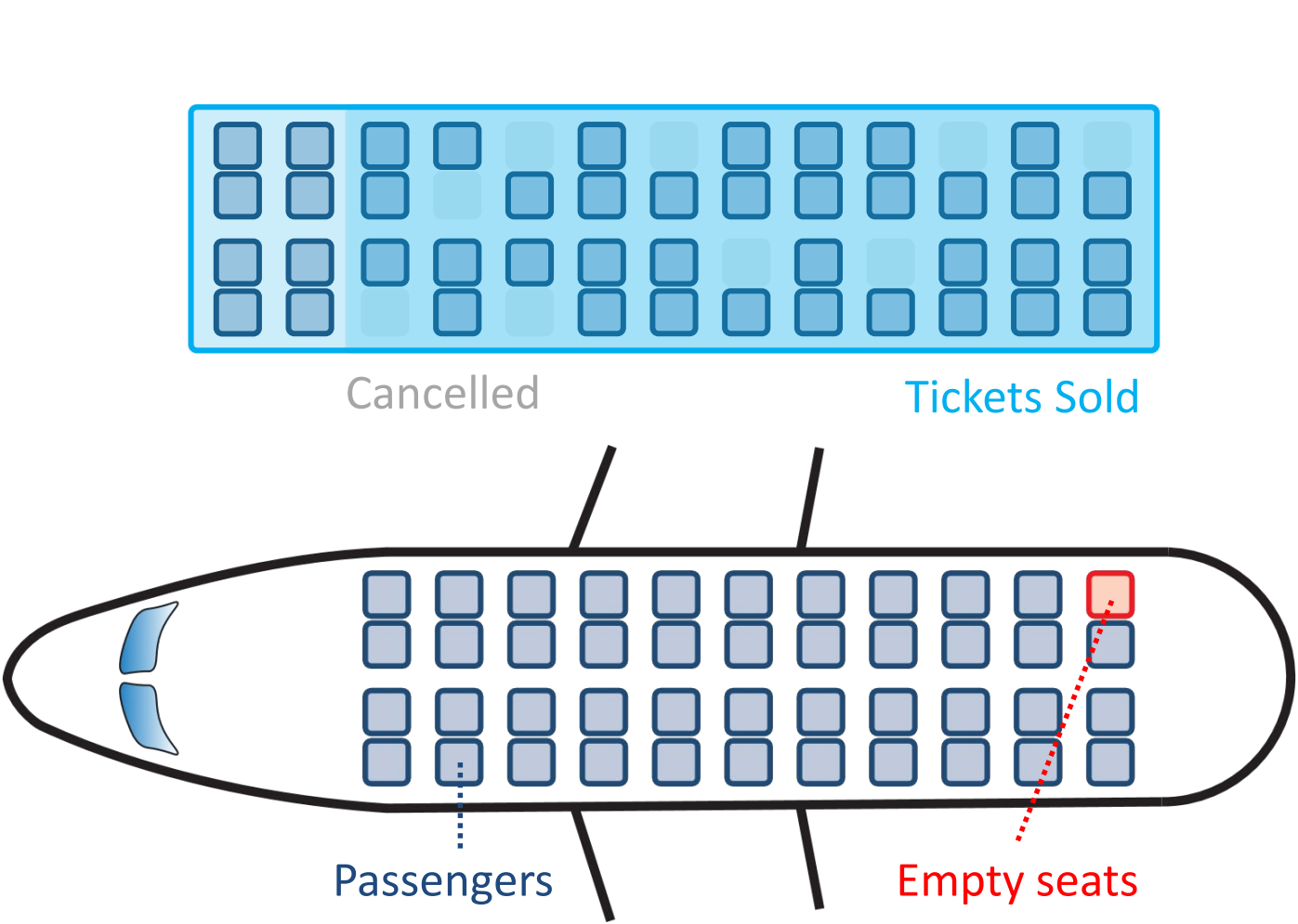

Overbooking improves utilization

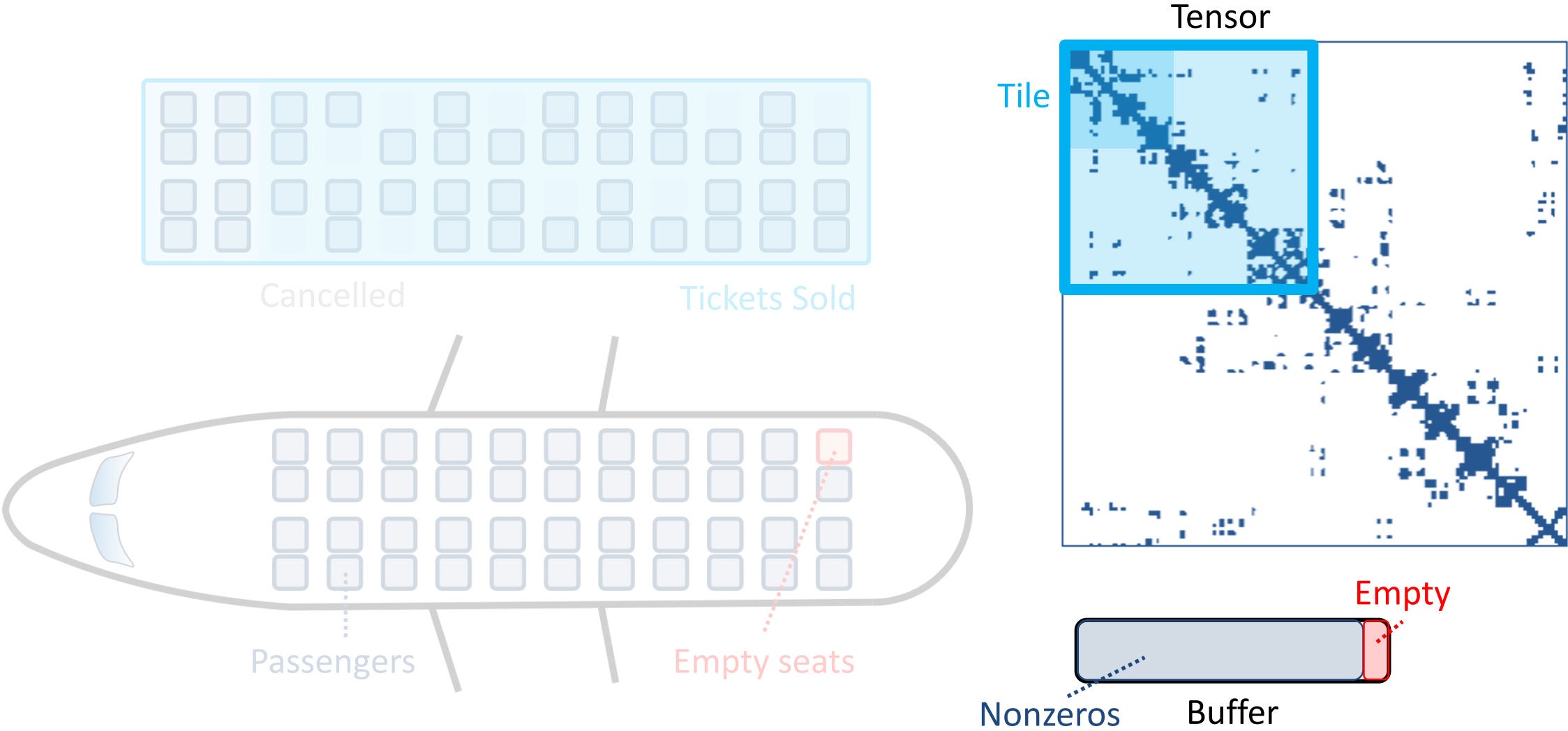

Overbooking improves utilization

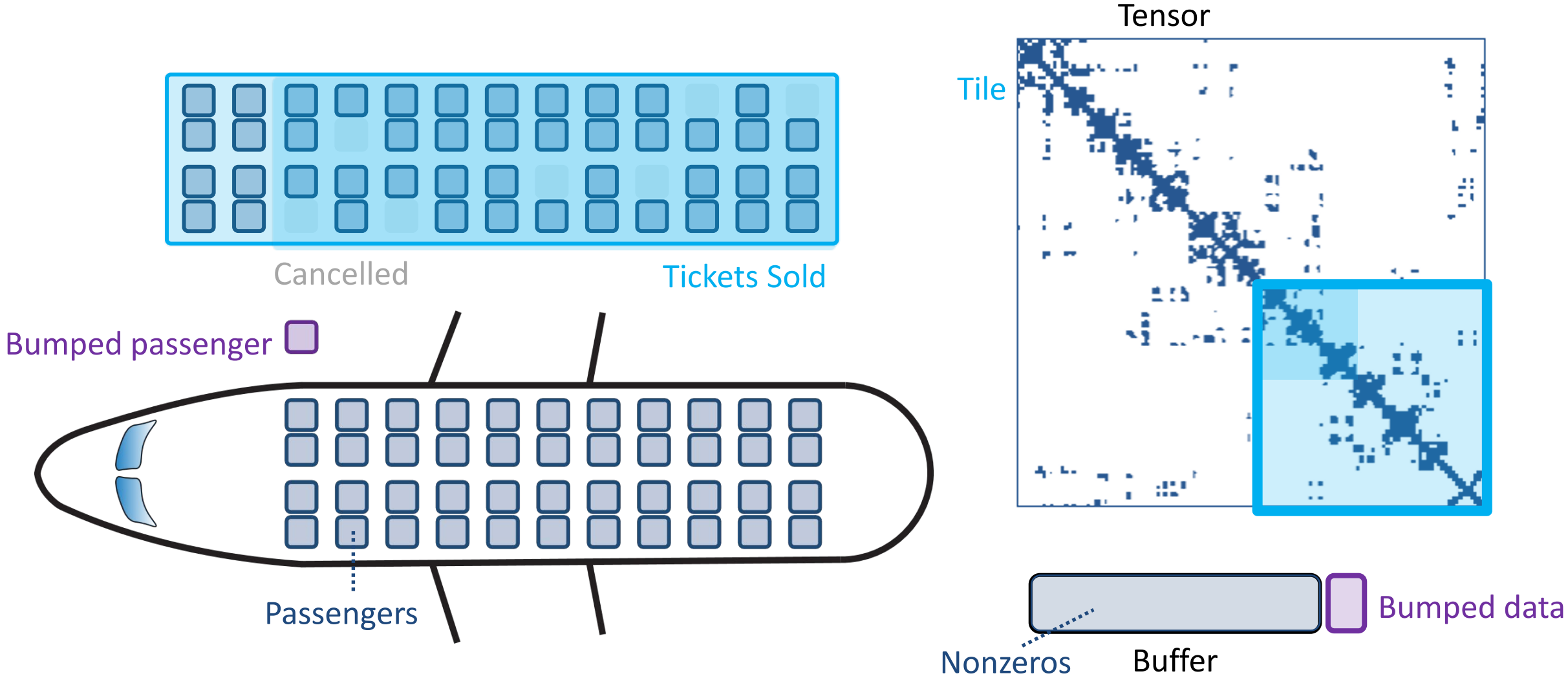

Overbooking improves utilization

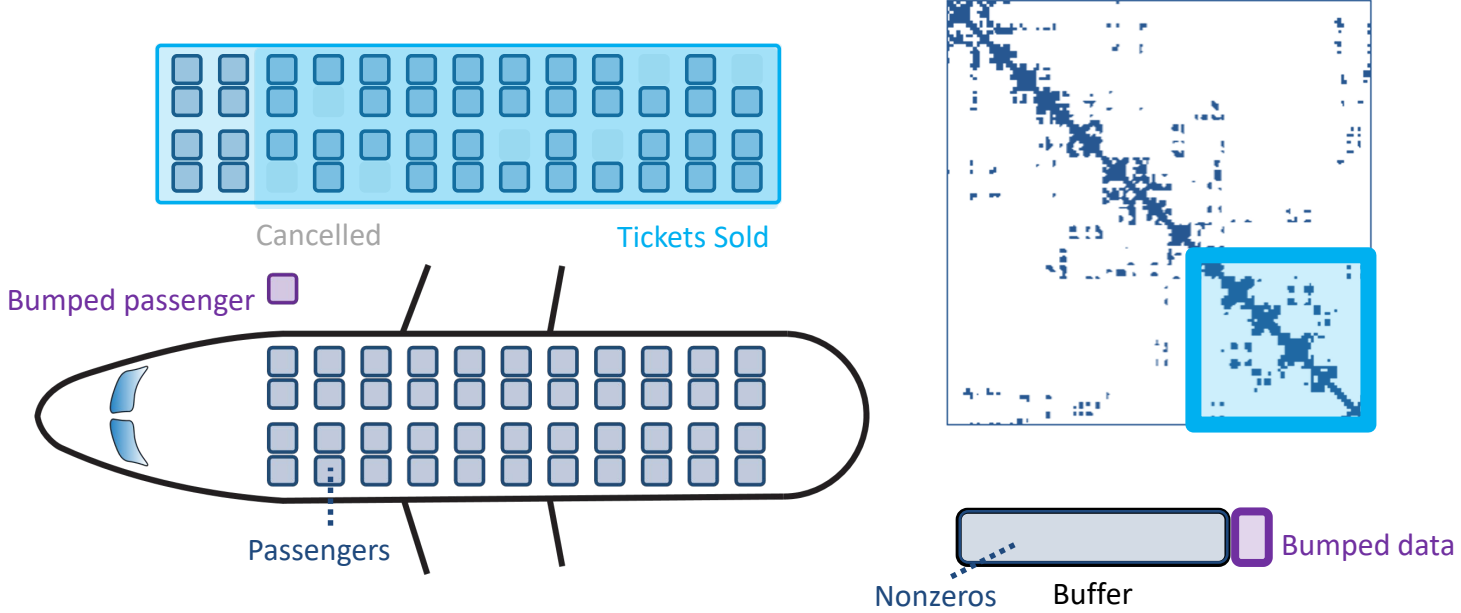

How do we deal with the bumped data?
Tailors
How do we determine how much to overbook?
Swiftiles

Managing unbumped data

Objective: minimize DRAM traffic
by maximizing data reuse

Traversal order
A B C A B C ...

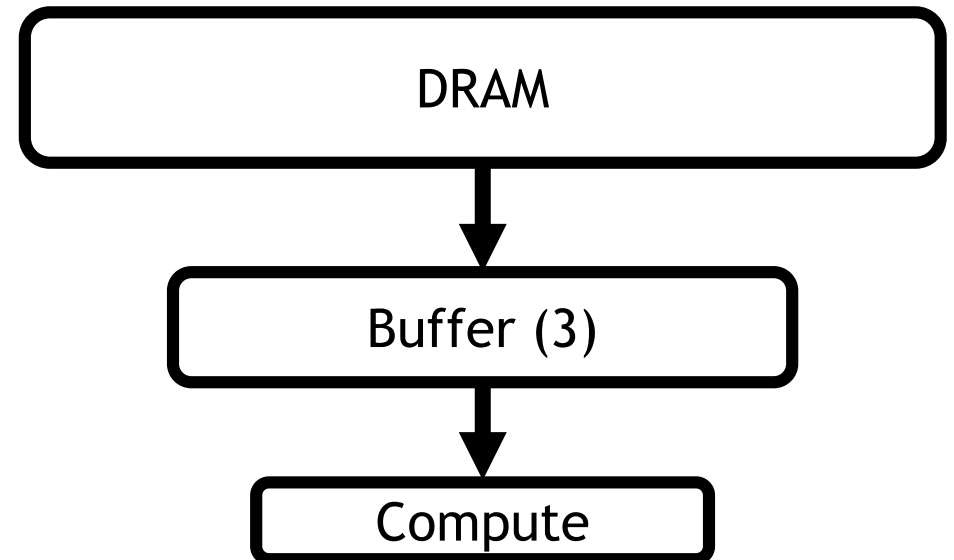
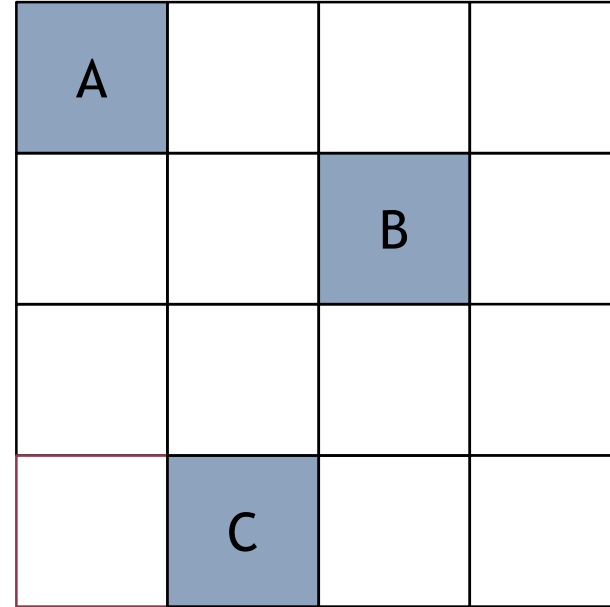

Managing unbumped data with buffets

- Buffets are used to orchestrate data in a number of domain-specific accelerators
- Buffets operate on a sliding window of data

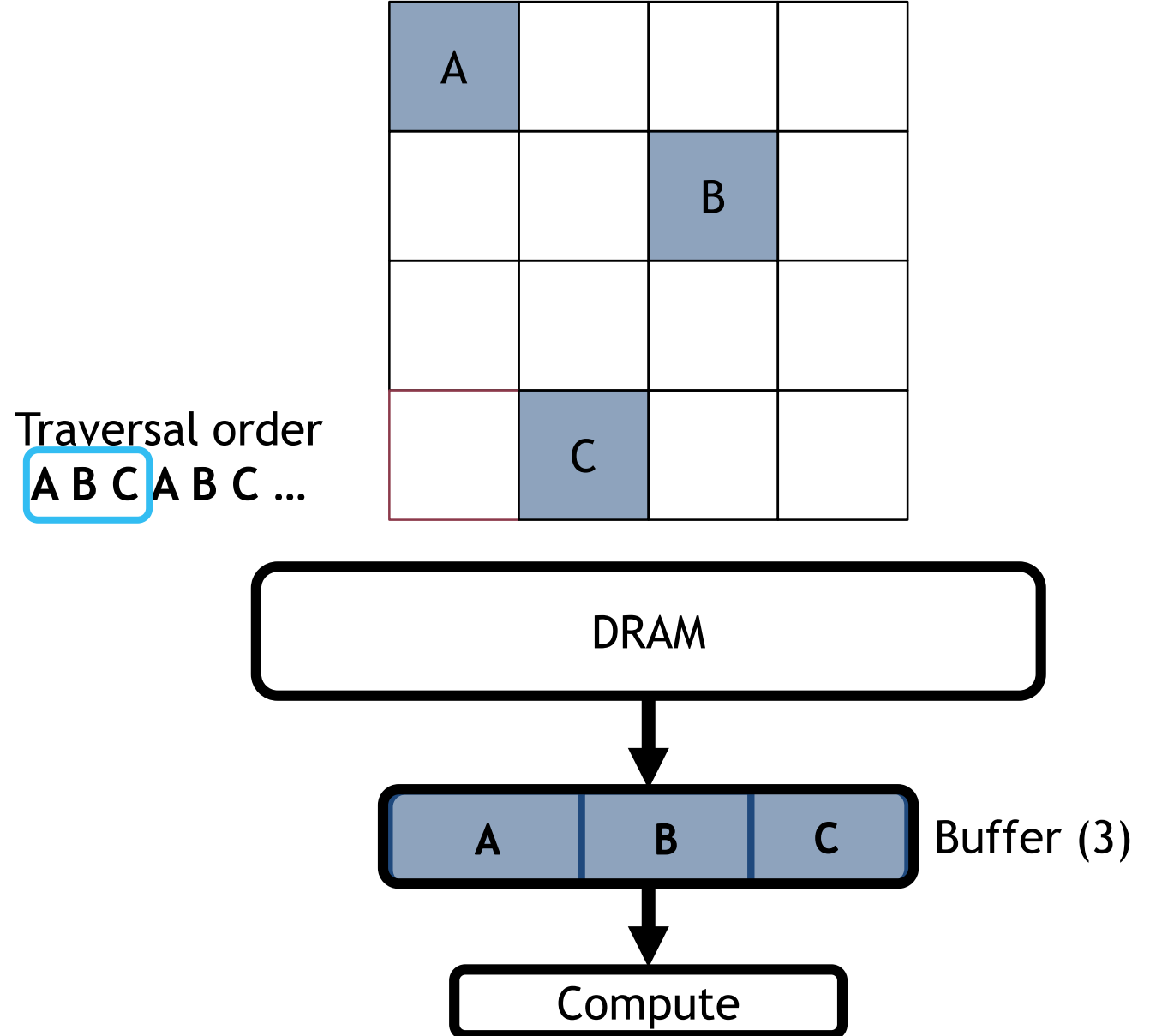

Managing bumped data with buffers

- Buffets operate on a sliding window of data
- Sliding window leads to poor data reuse when data is bumped

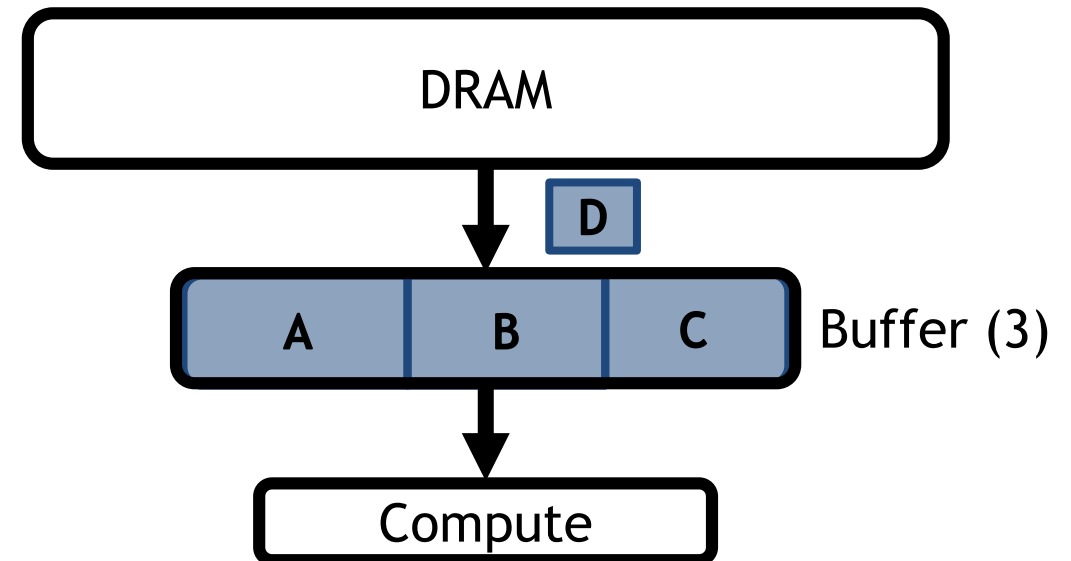
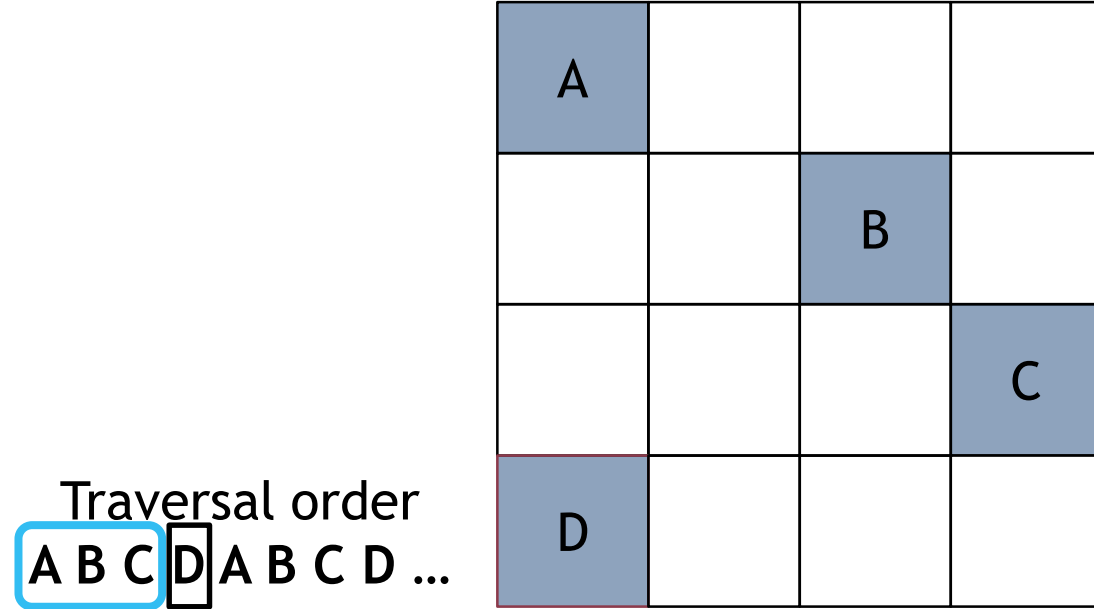

Managing bumped data with buffers

- Buffets operate on a sliding window of data
- Sliding window leads to poor data reuse when data is bumped

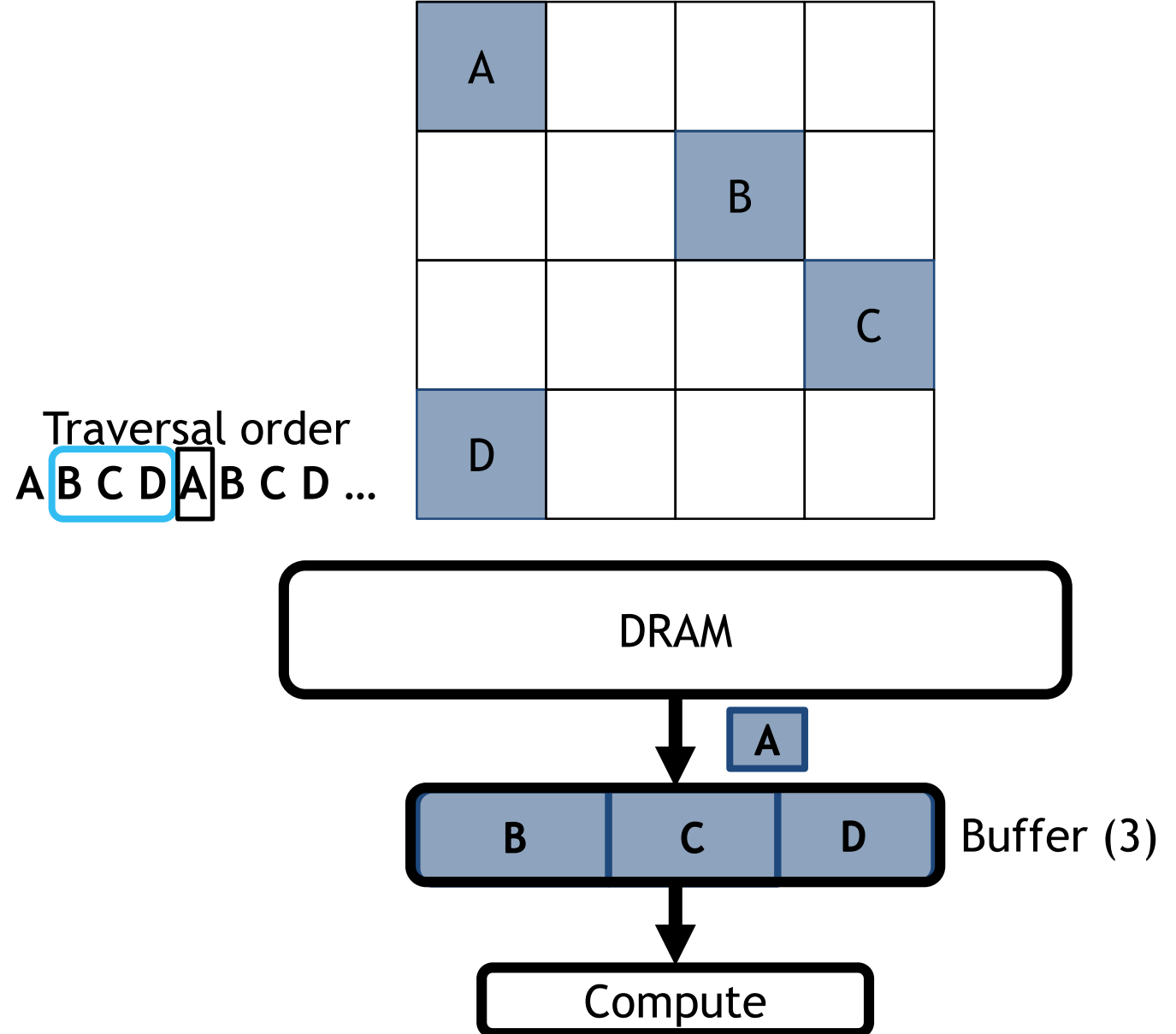

Managing bumped data with buffers

- Buffets operate on a sliding window of data
- Sliding window leads to poor data reuse when data is bumped

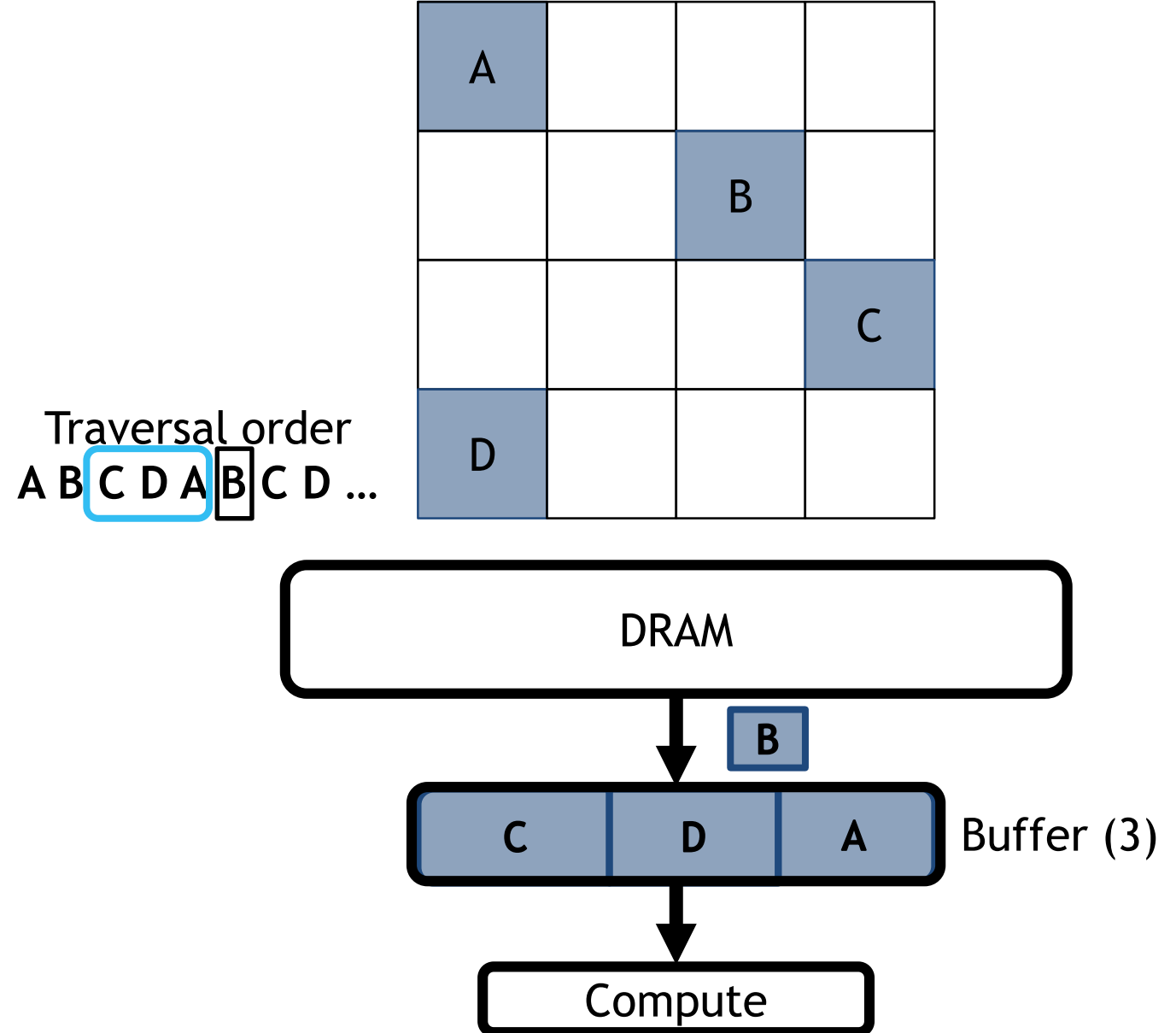

Tailors: Tail Overbooked Buffers for overbooked data

- Tailors dynamically splits the buffer when overbooked to stream bumped data through the tail of the buffer
- Lose reuse for **bumped data**, but not for **unbumped data**

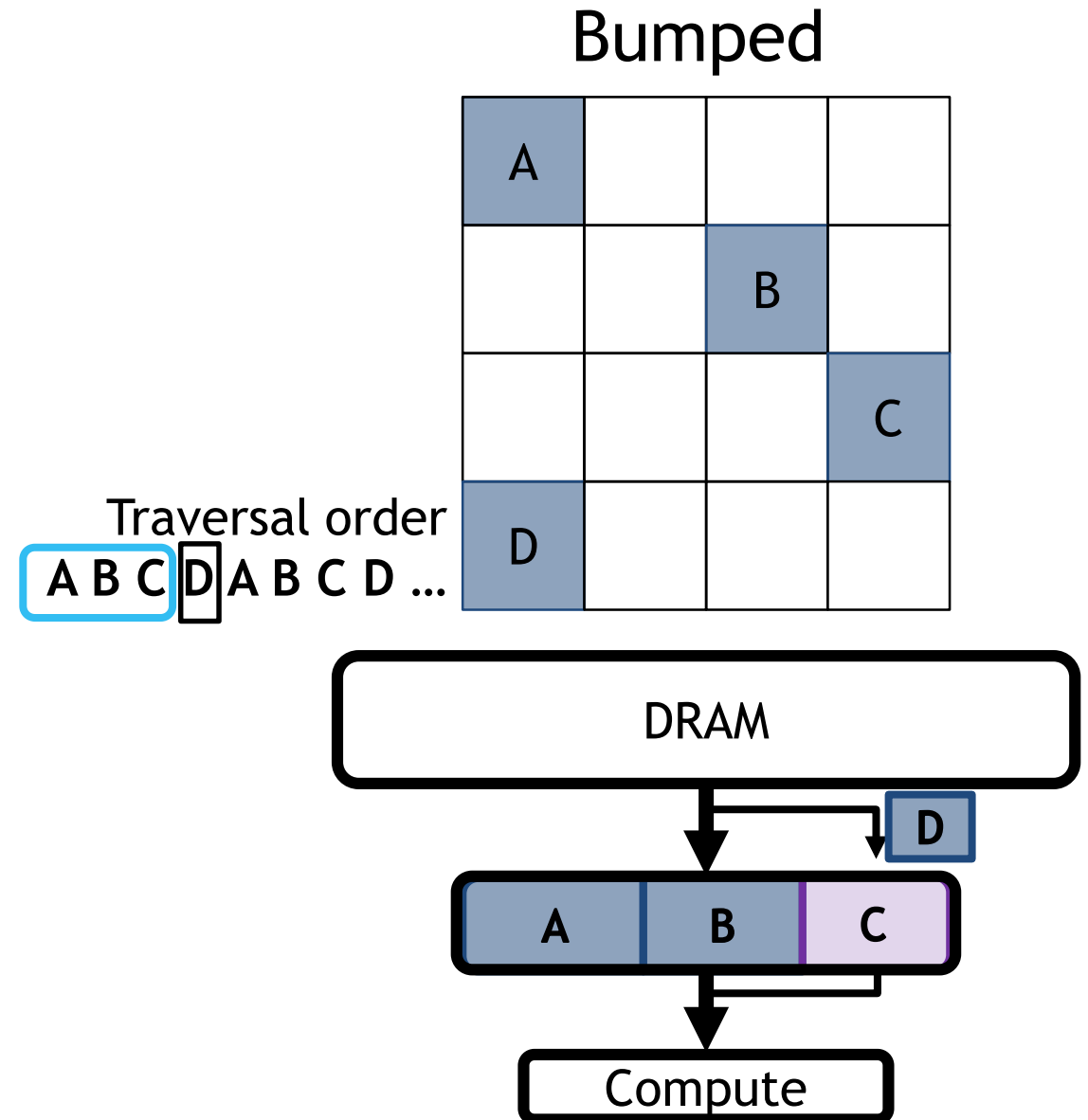

Tailors: Tail Overbooked Buffers for overbooked data

- Tailors dynamically splits the buffer when overbooked to stream bumped data through the tail of the buffer
- Lose reuse for **bumped data**, but not for **unbumped data**

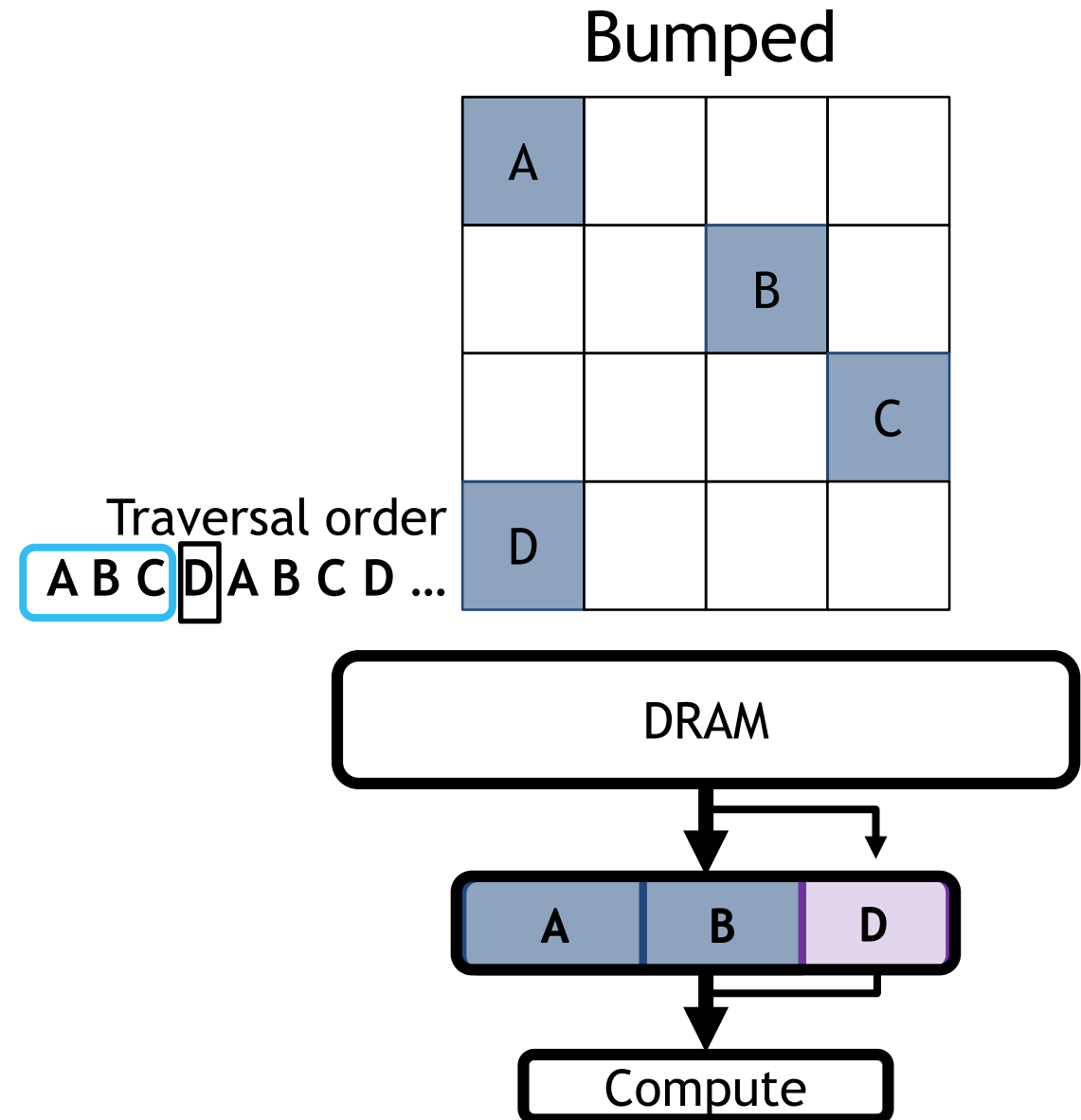

Tailors: Tail Overbooked Buffers for overbooked data

Unbumped

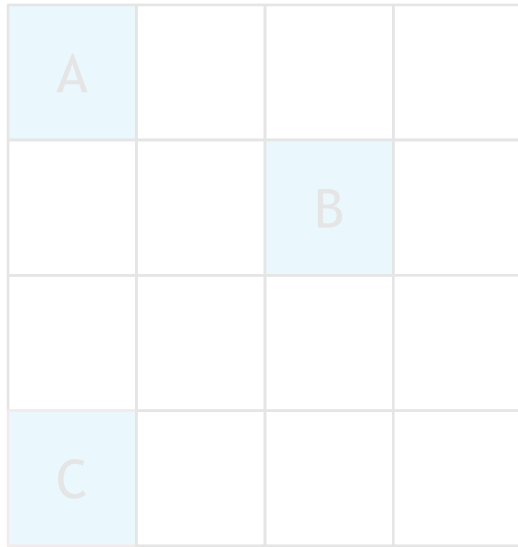

Traversal order
A B C A B C ...

Tailors behave like buffets when no data is bumped, but stream when data is bumped

Bumped

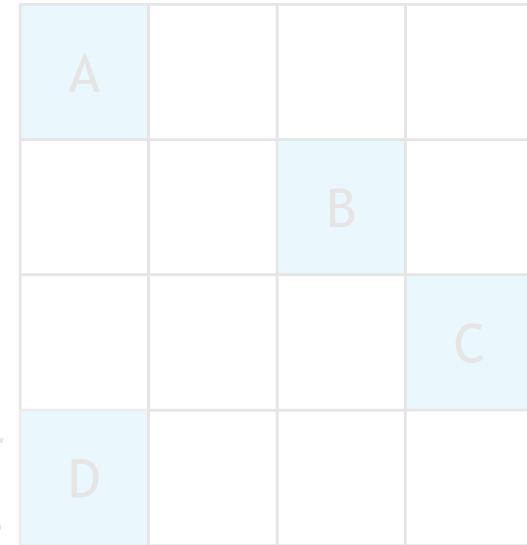

Traversal order
A B C D A B C D ...

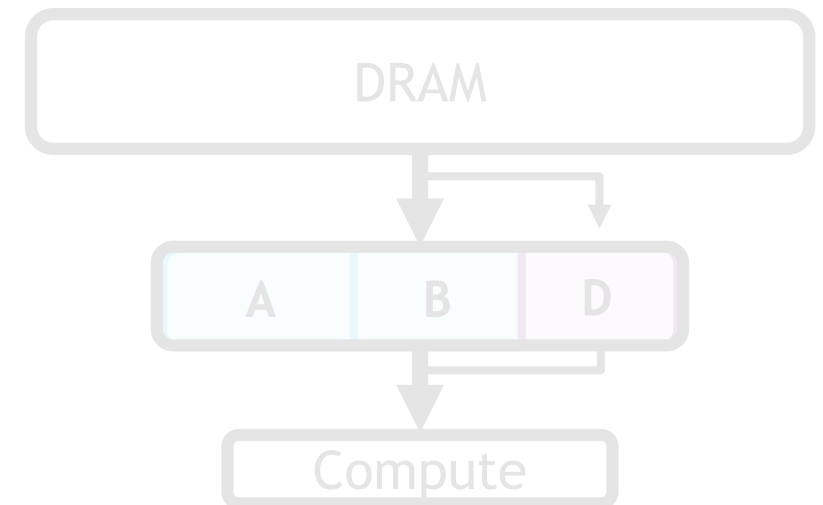
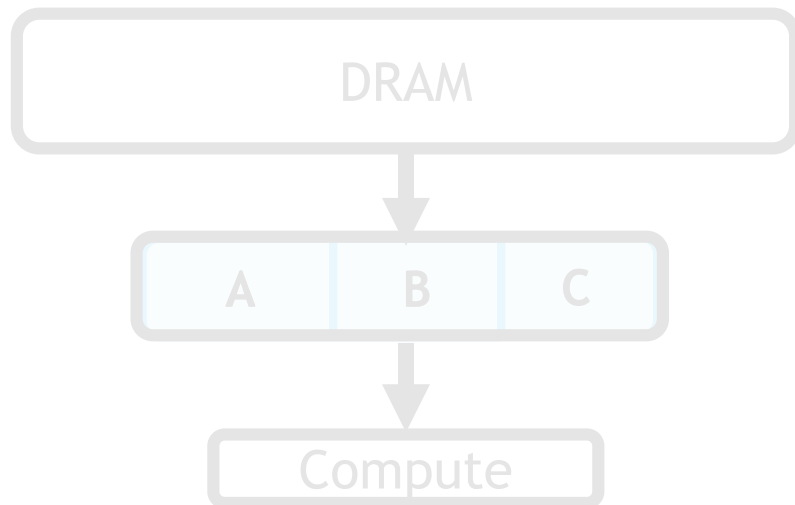

Determining the size of a tile is challenging

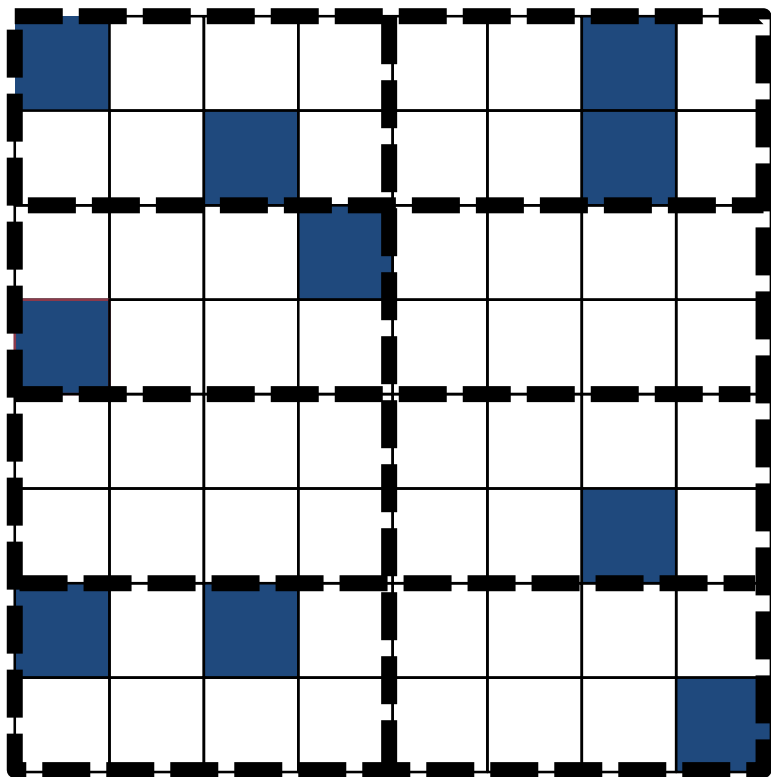

Full traversal to find maximum occupancy

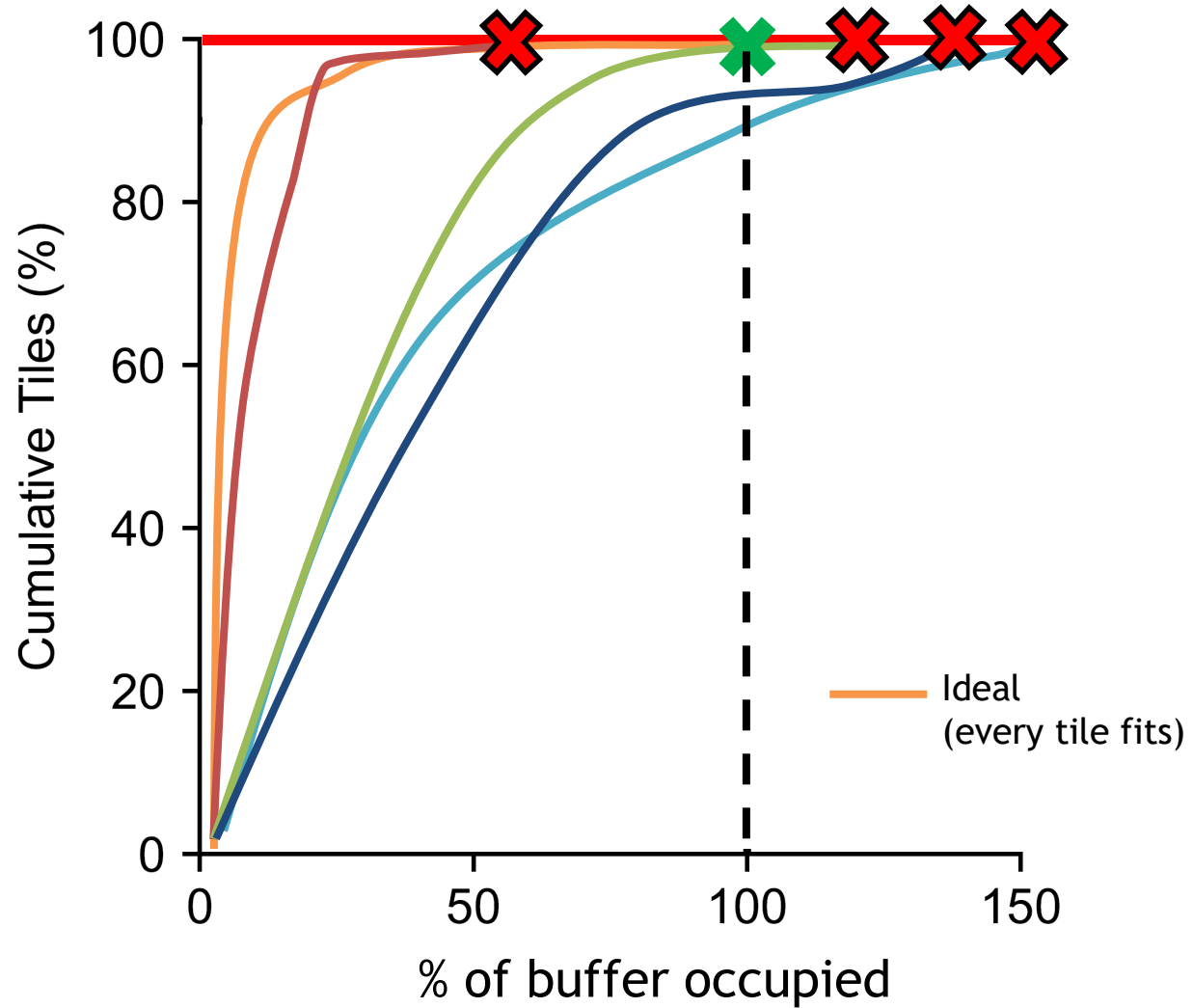
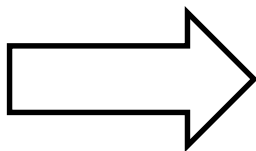

Swiftiles: A swift tiling algorithm for overbooking

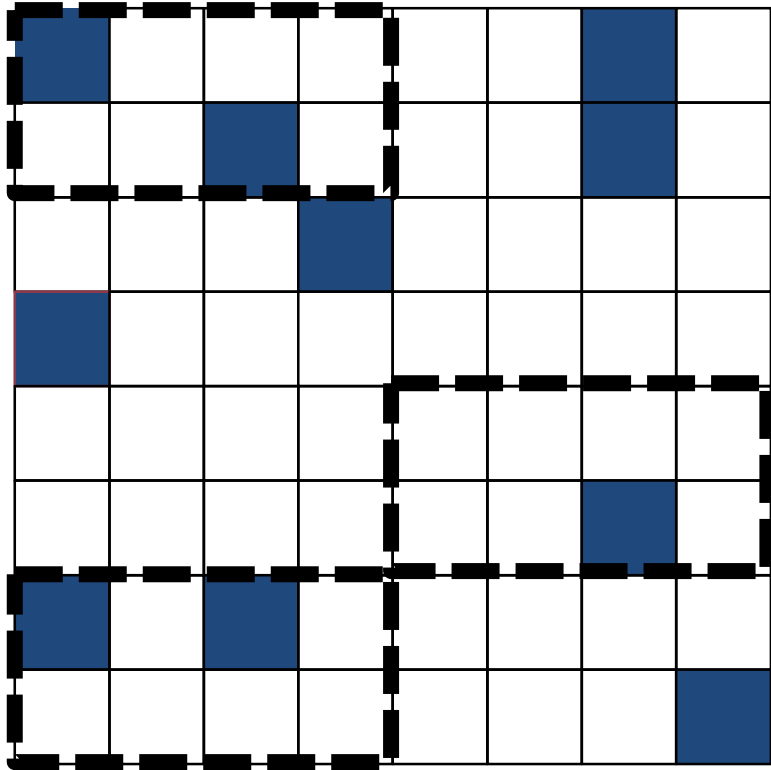

Random sampling to generate approximate occupancy distribution

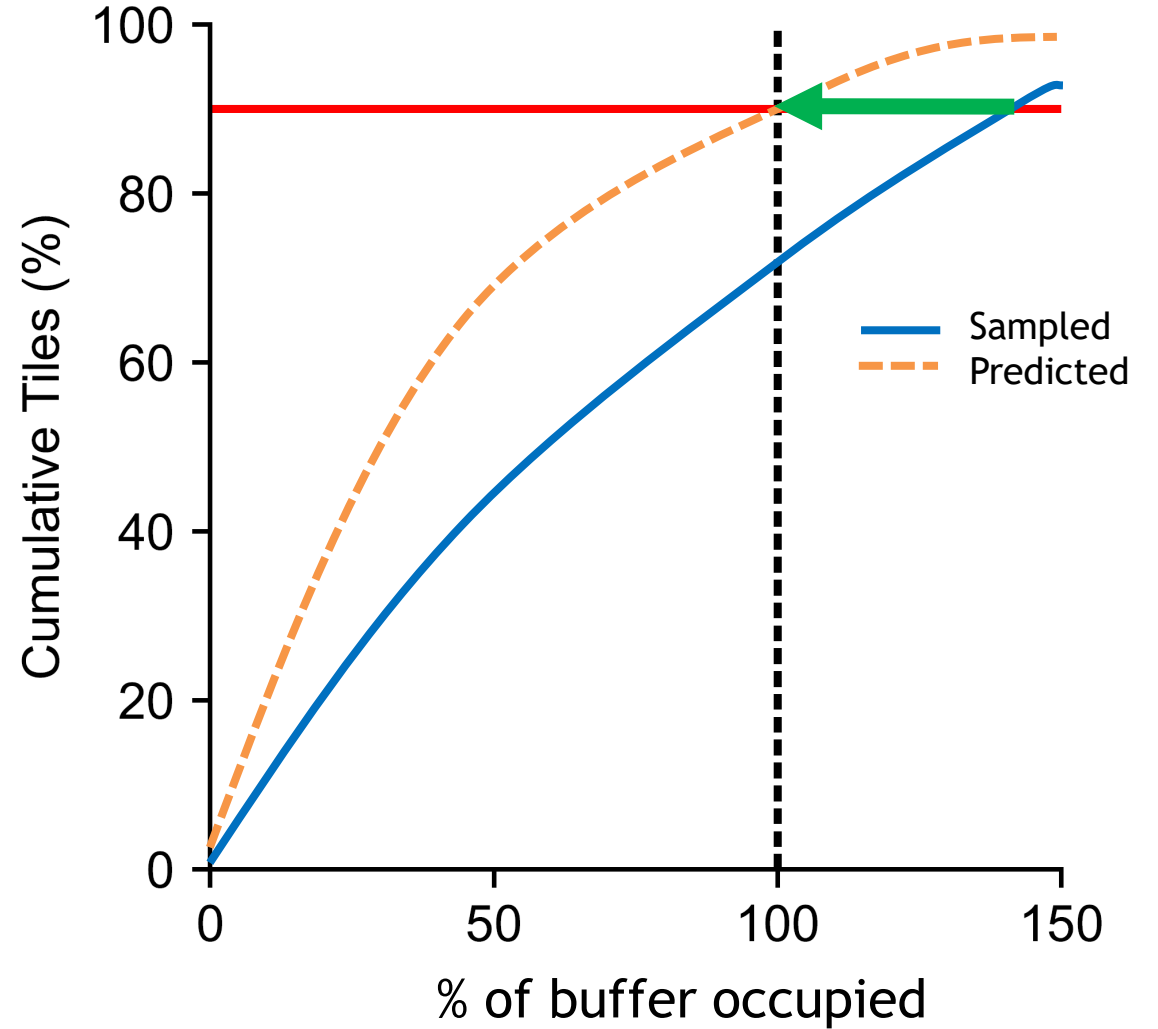

Scale distribution to buffer size

Evaluation against other tiling options

- **ExTensor-Naive**
 - No knowledge of tile occupancy, so must tile assuming dense tiles
- **ExTensor-Prescient**
 - Uses the maximum tile size where all tiles still fit in the buffer
- **ExTensor-Overbooking**
 - Tailors+Swiftiles where 90% of tiles fit in buffer

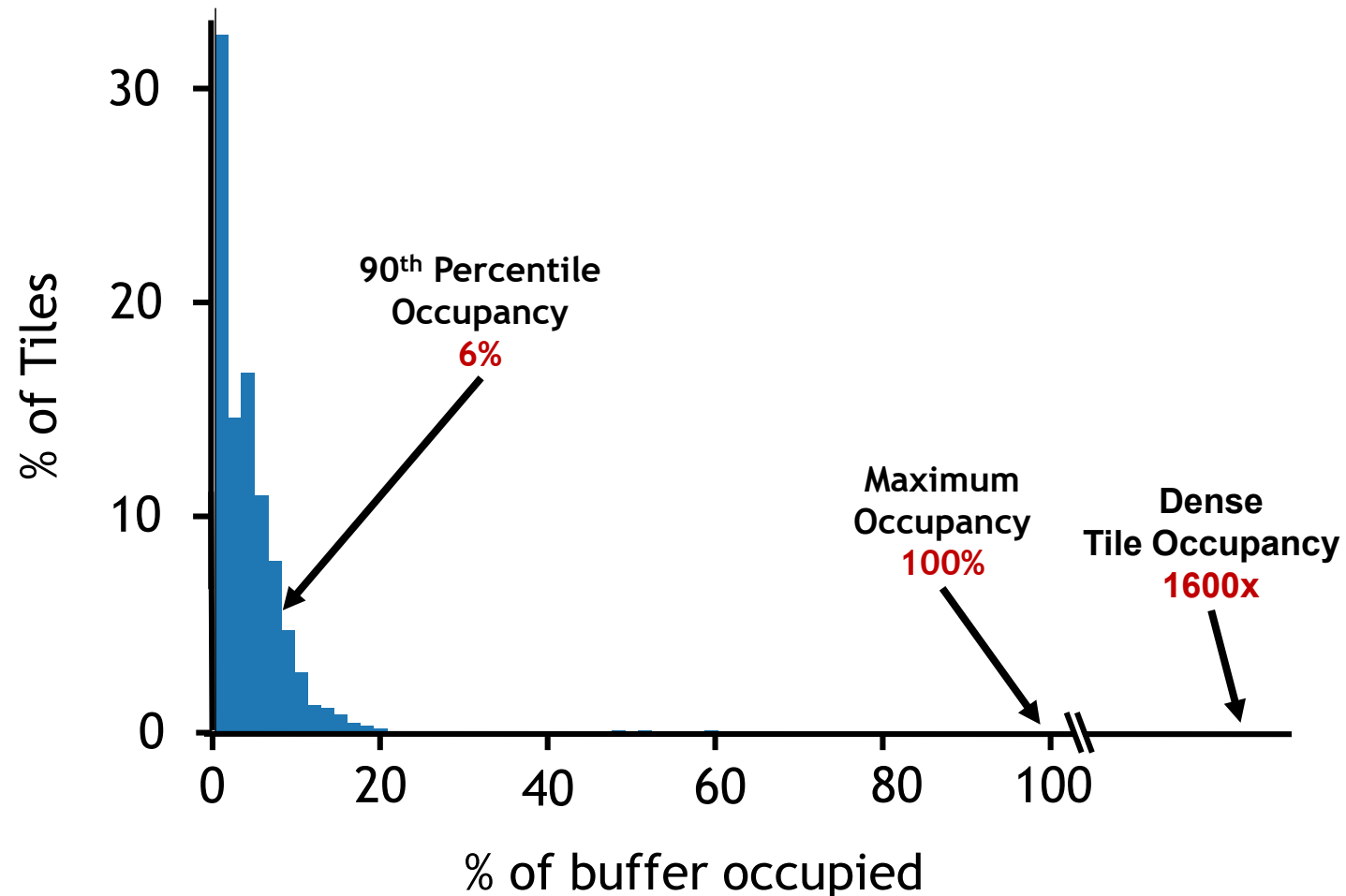

Results - Speedup over ExTensor-N

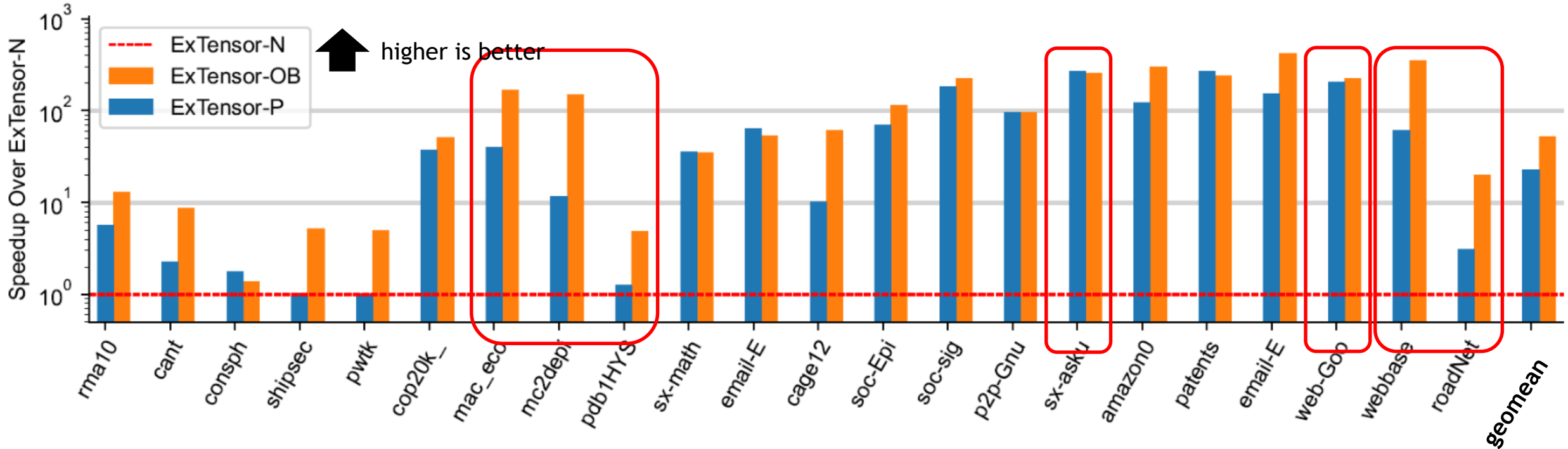

52.7x speedup over ExTensor-N, 2.3x over ExTensor-P

Results - Energy Efficiency relative to ExTensor-N

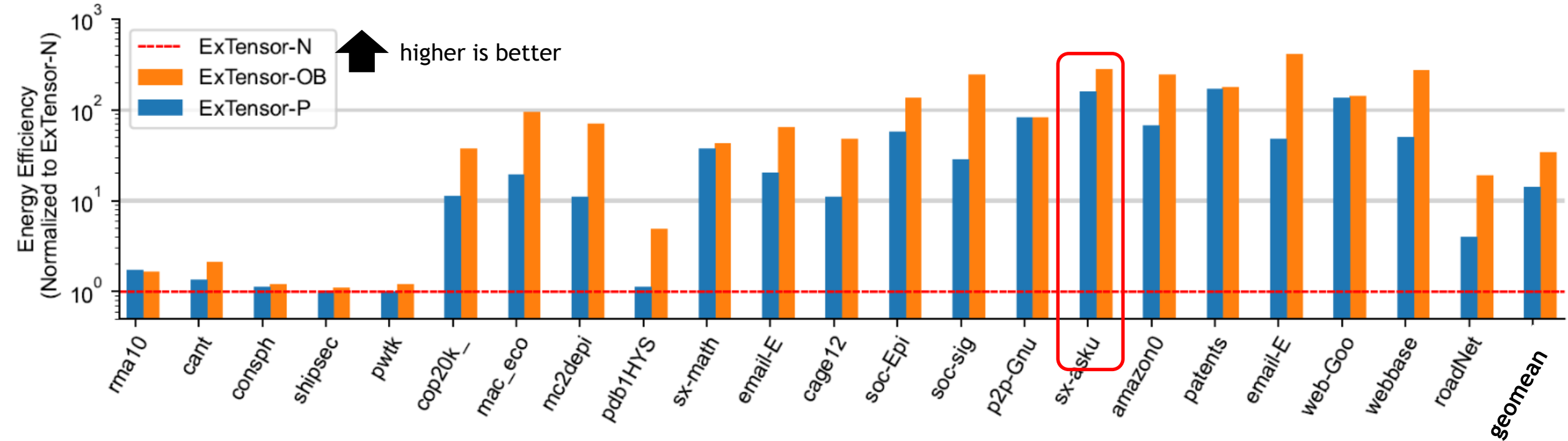

22.5x more energy efficient than ExTensor-N, 2.5x more than ExTensor-P

Results - DRAM traffic compared to ExTensor-P

- Bumped data has no data reuse while unbumped data does
- Increase in DRAM traffic due to streaming bumped data is offset by reduced DRAM traffic from larger tiles

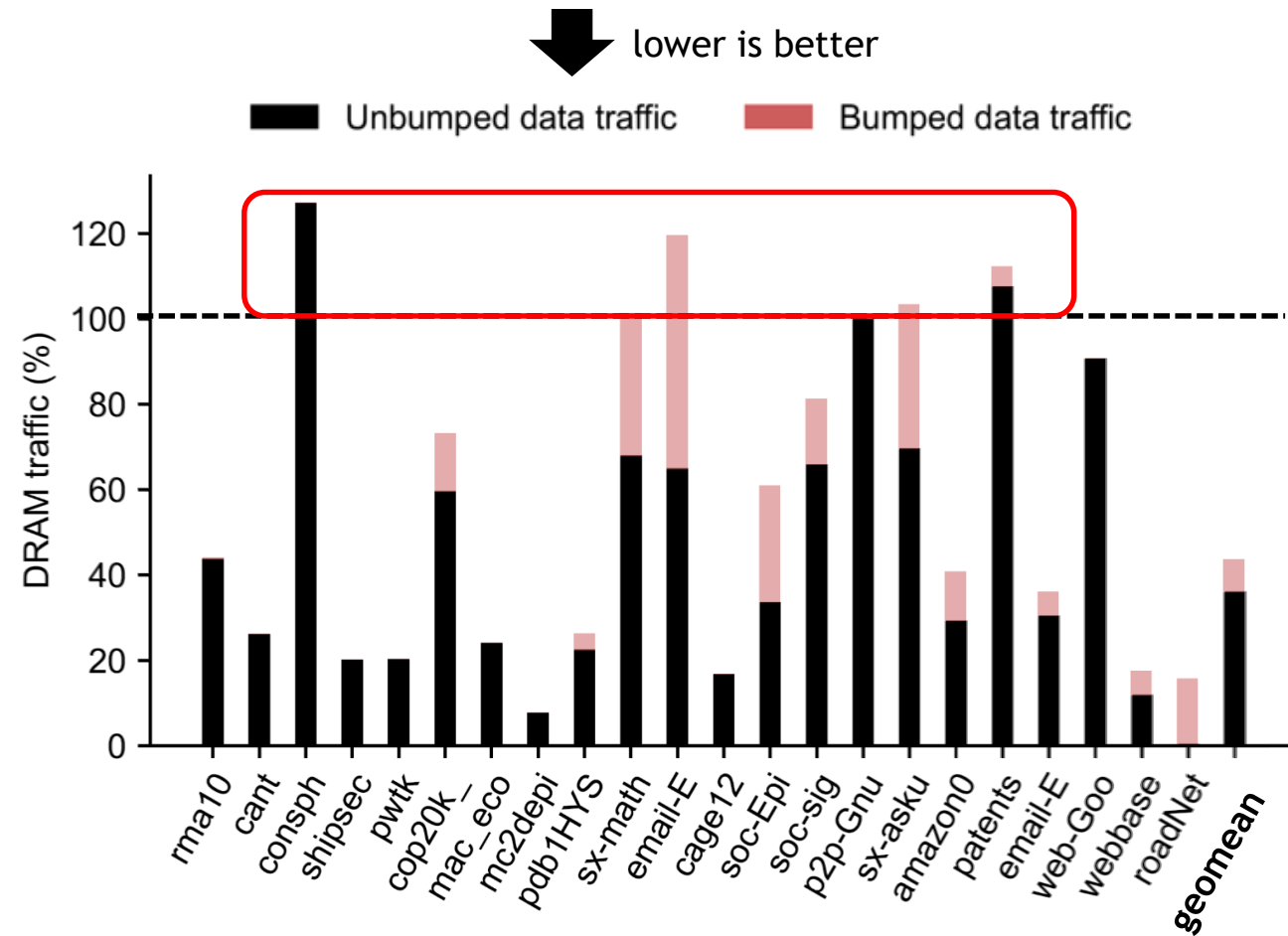

Key Takeaways

Overbooking

Intentionally under-provisioning buffer capacity can improve buffer utilization and reduce DRAM traffic

Tailors

Dynamically splitting buffer for bumped data maintains data reuse without additional area

Swiftiles

Samples tensor to estimate tile size with low preprocessing cost